

Agilent U1731C, U1732C, and U1733C Handheld LCR Meter

User's Guide



Agilent Technologies

Notices

© Agilent Technologies, Inc. 2011–2012

No part of this manual may be reproduced in any form or by any means (including electronic storage and retrieval or translation into a foreign language) without prior agreement and written consent from Agilent Technologies, Inc. as governed by United States and international copyright laws.

Manual Part Number

U1731-90077

Edition

Seventh Edition, November 28, 2012

Agilent Technologies, Inc.
5301, Stevens Creek Blvd.
Santa Clara, CA 95051 USA

Warranty

The material contained in this document is provided “as is,” and is subject to change, without notice, in future editions. Further, to the maximum extent permitted by the applicable law, Agilent disclaims all warranties, either express or implied, with regard to this manual and any information contained herein, including but not limited to the implied warranties of merchantability and fitness for a particular purpose. Agilent shall not be liable for errors or for incidental or consequential damages in connection with the furnishing, use, or performance of this document or of any information contained herein. Should Agilent and the user have a separate written agreement with warranty terms covering the material in this document that conflict with these terms, the warranty terms in the separate agreement shall control.

Technology Licenses

The hardware and/or software described in this document are furnished under a license and may be used or copied only in accordance with the terms of such license.

Restricted Rights Legend

U.S. Government Restricted Rights. Software and technical data rights granted to the federal government include only those rights customarily provided to end user customers. Agilent provides this customary commercial license in Software and technical data pursuant to FAR 12.211 (Technical Data) and 12.212 (Computer Software) and, for the Department of Defense, DFARS 252.227-7015 (Technical Data - Commercial Items) and DFARS 227.7202-3 (Rights in Commercial Computer Software or Computer Software Documentation).

Safety Notices

CAUTION

















A **CAUTION** notice denotes a hazard. It calls attention to an operating procedure, practice, or the likes of that, if not correctly performed or adhered to, could result in damage to the product or loss of important data. Do not proceed beyond a **CAUTION** notice until the indicated conditions are fully understood and met.

WARNING

A **WARNING** notice denotes a hazard. It calls attention to an operating procedure, practice, or the likes of that, if not correctly performed or adhered to, could result in personal injury or death. Do not proceed beyond a **WARNING** notice until the indicated conditions are fully understood and met.

Safety Symbols

The following symbols on the instrument and in the documentation indicate precautions which must be taken to maintain safe operation of the instrument.

	Direct current (DC)		Off (supply)
	Alternating current (AC)		On (supply)
	Both direct and alternating current		Caution, risk of electric shock
	Three-phase alternating current		Caution, risk of danger (refer to this manual for specific Warning or Caution information)
	Earth (ground) terminal		Caution, hot surface
	Protective conductor terminal		Out position of a bi-stable push control
	Frame or chassis terminal		In position of a bi-stable push control
	Equipotentiality		Equipment protected throughout by double insulation or reinforced insulation

Safety Considerations

Read the information below before using this instrument.

The following general safety precautions must be observed during all phases of operation, service, and repair of this instrument. Failure to comply with these precautions or with specific warnings elsewhere in this manual violates safety standards for design, manufacture, and intended use of the instrument. Agilent Technologies assumes no liability for the customer's failure to comply with these requirements.

CAUTION

- Disconnect circuit power and discharge all high-voltage capacitors before testing.
 - When measuring in-circuit components, first de-energize the circuits before connecting them to the test leads.
 - This device is for indoor use at altitudes of up to 2000 m.
 - Always use the specified battery type (listed in "[Product Characteristics](#)" on page 76). The power for the meter is supplied with a single standard 9 V battery. Observe the correct polarity markings before you insert the battery to ensure proper insertion of the battery in the meter.
 - Line operation is also possible using a 12 V AC to DC adapter. If a power adapter is selected, please be sure it meets the safety requirements of a relevant IEC standard.
-

WARNING

- **Use this meter only as specified in this manual; otherwise, the protection provided by the meter may be impaired.**
 - **Do not use the meter if it is damaged. Before you use the meter, inspect the case. Look for cracks or missing plastic. Pay particular attention to the insulation surrounding the connectors.**
 - **Inspect the test leads for damaged insulation or exposed metal. Check the test leads for continuity. Replace damaged test leads before you use the meter.**
 - **Do not operate the meter around explosive gas, vapor, or wet environments.**
 - **Never use the meter in wet conditions or when there is water on the surface. If the meter is wet, ensure that the meter is dried only by trained personnel.**
 - **When servicing the meter, use only the specified replacement parts.**
 - **When using the probes, keep your fingers behind the finger guards on the probes.**
 - **Connect the common test lead before you connect the live test lead. When you disconnect the leads, disconnect the live test lead first.**
 - **Remove the test leads from the meter before you open the battery cover.**
 - **Do not operate the meter with the battery cover or portions of the cover removed or loosened.**
 - **To avoid false readings, which may lead to possible electric shock or personal injury, replace the battery as soon as the low battery indicator appears and flashes.**
-

Environmental Conditions

This instrument is designed for indoor use and in an area with low condensation. The table below shows the general environmental requirements for this instrument.





Environmental conditions	Requirements
Operating temperature	Full accuracy from –10 °C to 55 °C
Operating humidity	Full accuracy up to 80% RH (relative humidity)
Storage temperature	–20 °C to 70 °C
Storage humidity	0% to 80% RH non-condensing
Altitude	Up to 2000 meters
Pollution degree	Pollution degree II

NOTE

The U1731C/U1732C/U1733C Handheld LCR Meter complies with the following safety and EMC requirements:

- IEC61010-1:2001/EN61010-1:2001 (Second Edition)
- IEC 61326-1:2005/EN 61326-1:2006
- Canada: ICES/NMB-001:Issue 4, June 2006
- Australia/New Zealand: AS/NZS CISPR11:2004

Regulatory Markings

 <p>ISM 1-A</p>	<p>The CE mark is a registered trademark of the European Community. This CE mark shows that the product complies with all the relevant European Legal Directives.</p>	 <p>N10149</p>	<p>The C-tick mark is a registered trademark of the Spectrum Management Agency of Australia. This signifies compliance with the Australia EMC Framework regulations under the terms of the Radio Communication Act of 1992.</p>
<p>ICES/NMB-001</p>	<p>ICES/NMB-001 indicates that this ISM device complies with the Canadian ICES-001. Cet appareil ISM est conforme a la norme NMB-001 du Canada.</p>		<p>This instrument complies with the WEEE Directive (2002/96/EC) marking requirement. This affixed product label indicates that you must not discard this electrical or electronic product in domestic household waste.</p>
	<p>This symbol indicates the time period during which no hazardous or toxic substance elements are expected to leak or deteriorate during normal use. Forty years is the expected useful life of the product.</p>		

Waste Electrical and Electronic Equipment (WEEE) Directive 2002/96/EC

This instrument complies with the WEEE Directive (2002/96/EC) marking requirement. This affixed product label indicates that you must not discard this electrical or electronic product in domestic household waste.

Product Category:

With reference to the equipment types in the WEEE directive Annex 1, this instrument is classified as a “Monitoring and Control Instrument” product.

The affixed product label is as shown below.



Do not dispose in domestic household waste.

To return this unwanted instrument, contact your nearest Agilent Service Centre, or visit

www.agilent.com/environment/product

for more information.

Declaration of Conformity (DoC)

The Declaration of Conformity (DoC) for this instrument is available on the Agilent website. You can search the DoC by its product model or description at the web address below.

<http://regulations.corporate.agilent.com/DoC/search.htm>

NOTE

If you are unable to search for the respective DoC, please contact your local Agilent representative.

THIS PAGE HAS BEEN INTENTIONALLY LEFT BLANK.

Table of Contents

1 Introduction

About This Manual	2
Documentation map	2
Safety notes	2
Preparing Your LCR Meter	3
Check the shipment	3
Install the battery	3
Turn on your LCR meter	5
Automatic Power-Off (APO)	6
Enabling the backlight	6
Selecting the range	7
Adjusting the tilt stand	8
Connecting the IR-USB cable	9
Power-on options	10
Your LCR Meter in Brief	11
Dimensions	11
Overview	13
Keypad	15
Display screen	18
Input terminals	22
Cleaning Your LCR Meter	23

2 Features and Functions

Making Measurements	26
Auto Identification (Ai) function	26
Measuring inductance (L)	29
Measuring capacitance (C)	31
Measuring resistance (R)	33
Measuring impedance (Z)	35

Measuring dissipation factor/quality factor/phase angle (D/Q/θ)	37
Changing the test frequency	37
Selecting parallel/series circuit mode (P/S)	37
Setting the standard reference tolerance (Tol%)	38
Enabling ESR measurements	39
Enabling DCR measurements	39
Additional Features	40
Freezing the display (Hold)	40
Enabling the static recording mode (Rec)	40
Setting the high/low limit comparison (Limit)	42
Making relative measurements (Null)	45
Performing the open/short CAL	46

3 Setup Options

Using the Setup Menu	52
Editing numerical values	53
Setup Menu Summary	54
Setup Menu Items	56
Changing the initial power-on behavior	56
Changing the Ai function's phase angle condition	63
Changing the power-on limit category and set	65
Changing the user high/low limit values	66
Changing the baud rate	68
Changing the parity check	69
Changing the data bits	70
Changing the beep frequency	71
Locking the push buttons	72
Changing the auto power-off and backlight time-outs	73
Resetting the Setup items	74

4 Characteristics and Specifications

Product Characteristics	76
Specification Assumptions	77
Electrical Specifications	78
Impedance/Resistance/DCR specifications	78
Capacitance specifications	79
Inductance specifications	80
Phase angle of impedance specifications	81
Dissipation/Quality factor specifications	82
Test signal specifications	83
Source impedance of impedance/resistance measurement	84
Source impedance of capacitance measurement	85
Source impedance of inductance measurement	86
SMD Tweezers Specifications	87
Electrical characteristics	88

List of Figures

Figure 1-1	Installing the batteries	4
Figure 1-2	Power-on button	5
Figure 1-3	Tilt-stand adjustment and IR cable connection	8
Figure 1-4	Agilent GUI Data Logger Software	9
Figure 1-5	Width dimensions	11
Figure 1-6	Height and depth dimensions	12
Figure 1-7	Front panel	13
Figure 1-8	Rear panel	14
Figure 2-1	Using the Ai function	26
Figure 2-2	Inductance measurement with Q factor	29
Figure 2-3	Measuring inductance	30
Figure 2-4	Capacitance measurement with D factor	31
Figure 2-5	Measuring capacitance	32
Figure 2-6	Resistance measurement	33
Figure 2-7	Measuring resistance	34
Figure 2-8	Impedance measurement with theta	35
Figure 2-9	Measuring impedance	36
Figure 2-10	Component above setting tolerance	38
Figure 2-11	ESR measurement with theta	39
Figure 2-12	DCR measurement	39
Figure 2-13	Using the Hold function	40
Figure 2-14	Using the Rec function	41
Figure 2-15	Using the Limit function	43
Figure 2-16	High and low limit values	44
Figure 2-17	nGo and Go indications	44
Figure 2-18	Using the Null function	45
Figure 2-19	Using the Cal function	47
Figure 2-20	Open calibration and short calibration prompts	48
Figure 3-1	Changing the power-on measurement type	57
Figure 3-2	Changing the power-on test frequency	58
Figure 3-3	Changing the power-on secondary parameter and measurement mode for inductance (L) measurements	59
Figure 3-4	Changing the power-on secondary parameter and measurement mode for capacitance (C)	

	measurements	60
Figure 3-5	Changing the power-on secondary parameter and measurement mode for resistance (R) measurements	61
Figure 3-6	Changing the power-on open/short CAL	62
Figure 3-7	Changing the Ai function's phase angle condition	64
Figure 3-8	Changing the power-on limit and category set	65
Figure 3-9	Changing the user high/low limit values	67
Figure 3-10	Changing the baud rate	68
Figure 3-11	Changing the parity check	69
Figure 3-12	Changing the data bits	70
Figure 3-13	Changing the beep frequency	71
Figure 3-14	Locking the push buttons	72
Figure 3-15	Changing the auto power-off and backlight time-outs	73
Figure 3-16	Resetting the Setup items	74
Figure 4-1	U1782B SMD tweezers	87

List of Tables

Table 1-1	Battery level indicator	5
Table 1-2	Power-on options	10
Table 1-3	Front panel parts	13
Table 1-4	Rear panel parts	14
Table 1-5	Keypad functions	15
Table 1-6	General annunciators	18
Table 1-7	Measurement units display	21
Table 1-8	Input terminal/socket connections	22
Table 2-1	Auto identification phase angle rules	27
Table 2-2	Auto identification series/parallel rules for resistance measurements	27
Table 2-3	Auto identification series/parallel rules for capacitance measurements	28
Table 2-4	Auto identification series/parallel rules for inductance measurements	28
Table 2-5	Available test frequencies	37
Table 2-6	Factory default high and low limit values	42
Table 3-1	Setup menu key functions	52
Table 3-2	Setup menu item descriptions	54
Table 3-3	Auto identification phase angle rules	63
Table 3-4	Default user high/low limit values	66
Table 4-1	Impedance/Resistance/DCR specifications	78
Table 4-2	Capacitance specifications	79
Table 4-3	Inductance specifications	80
Table 4-4	Phase angle of impedance specifications	81
Table 4-5	Dissipation/Quality factor specifications	82
Table 4-6	Test signal specifications	83
Table 4-7	Source impedance of impedance/resistance measurement	84
Table 4-8	Source impedance of capacitance measurement	85
Table 4-9	Source impedance of inductance measurement	86
Table 5	U1782B SMD tweezers electrical characteristics	88

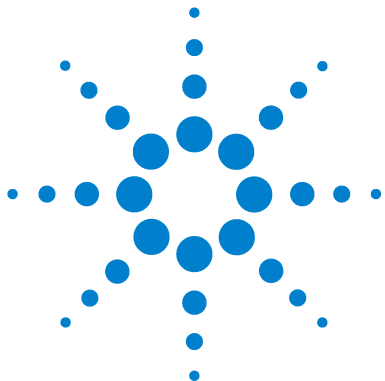

1 Introduction

About This Manual	2
Documentation map	2
Safety notes	2
Preparing Your LCR Meter	3
Check the shipment	3
Install the battery	3
Turn on your LCR meter	5
Automatic Power-Off (APO)	6
Enabling the backlight	6
Selecting the range	7
Adjusting the tilt stand	8
Connecting the IR-USB cable	9
Power-on options	10
Your LCR Meter in Brief	11
Dimensions	11
Overview	13
Keypad	15
Display screen	18
Input terminals	22
Cleaning Your LCR Meter	23

This chapter teaches you how to set up your LCR meter for the first time. An introduction to all the features and capabilities of the LCR meter is also given.



About This Manual

The descriptions and instructions in this manual apply to the Agilent U1731C, U1732C, and U1733C handheld LCR meters (hereafter referred to as the LCR meter).

The model U1733C appears in all illustrations.

Documentation map

The following manuals and software are available for your LCR meter. For the very latest version, please visit our website at: <http://www.agilent.com/find/hhTechLib>.

Check the manual revision on the first page of each manual.

- **User's Guide.** This manual.
- **Quick Start Guide.** Printed copy for outdoor use, included with shipment.
- **Agilent GUI Data Logger Software, Quick Start Guide, and Help.** Free download at the Agilent website.

Safety notes

Safety notes are used throughout this manual (see the “[Safety Notices](#)” section for format examples). Familiarize yourself with each of the notes and its meaning before operating your LCR meter.

More pertinent safety notes for using this product are located under the “[Safety Considerations](#)” section.

Do not proceed beyond a safety notice until the indicated conditions are fully understood and met.

Preparing Your LCR Meter

Check the shipment

When you receive your LCR meter, check the shipment according to the following procedure.

- 1 Inspect the shipping container for damage. Signs of damage may include a dented or torn shipping container or cushioning material that indicates signs of unusual stress or compacting. Save the packaging material in case the LCR meter needs to be returned.
- 2 Carefully remove the contents from the shipping container, and verify that the standard accessories and your ordered options are included in the shipment according to the standard shipped items list found in the printed copy of the *U1731C/U1732C/U1733C Quick Start Guide*.
- 3 For any question or problems, refer to the Agilent contact numbers on the back of this manual.

Install the battery

Your LCR meter is powered by a single 9 V alkaline battery (included with the shipment). When you receive your LCR meter, the 9 V alkaline battery is not installed.

Use the following procedure to install the battery.

CAUTION

Before you proceed with the battery installation, remove all cable connections to the terminals and ensure that the LCR meter is turned OFF. Use only the battery type specified in “[Product Characteristics](#)” on page 76.

- 1 Open the battery cover.** Lift the tilt stand. Loosen the screw with a suitable Phillips screwdriver and remove the battery cover as shown in [Figure 1-1](#).
- 2 Insert the battery.** Observe the proper battery polarity. The terminal ends of the battery are indicated inside the battery compartment.
- 3 Close the battery cover.** Place the battery cover back in its original position and tighten the screw.

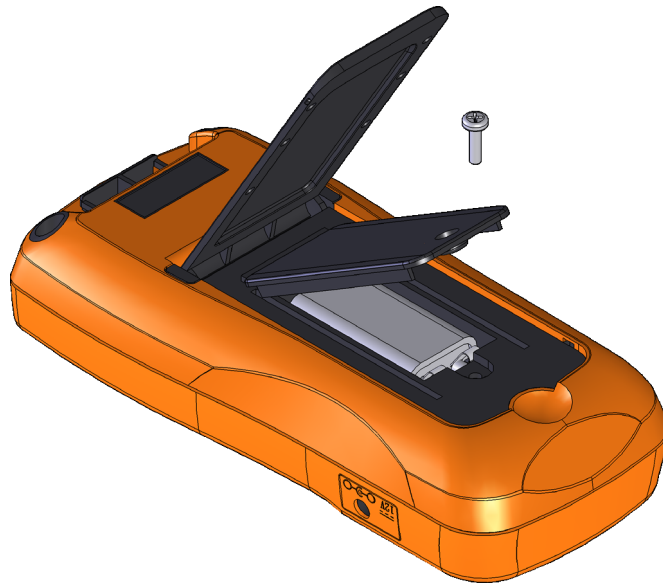

Figure 1-1 Installing the batteries

The battery level indicator in the lower right-hand corner of the display indicates the relative condition of the battery. [Table 1-1](#) describes the various battery levels the indicator represents.

WARNING





To avoid false readings, which could lead to possible electric shock or personal injury, replace the battery as soon as the low battery indicator appears. Do not discharge the battery by shorting the battery or reverse the battery polarity.

CAUTION

To avoid instruments being damage from battery leakage:

- Always remove dead batteries immediately.
- Always remove the battery and store it separately if the LCR meter is not going to be used for a long period.

Table 1-1 Battery level indicator

Indication	Battery capacity
	Full capacity
	2/3 capacity
	1/3 capacity
 (Flashing periodically)	Almost empty (less than one day) ^[1]

[1] Battery change advised. Always use the specified battery type listed in [page 76](#).

Turn on your LCR meter

To power ON your LCR meter, press the power-on button once. The LCR meter powers up in the auto identification (*AI*) mode (see [page 26](#)) when turned on for the first time.

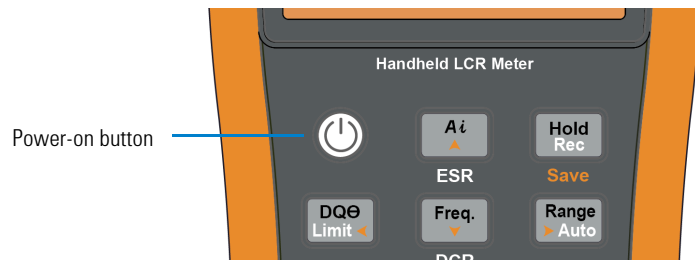

Figure 1-2 Power-on button

To power OFF your LCR meter, press the power-on button again.

NOTE

You can change the power-on behavior of your LCR meter for subsequent power cycles. See [“Changing the initial power-on behavior”](#) on page 56 for more information on changing the LCR meter’s power-on setting.

Automatic Power-Off (APO)

Your LCR meter automatically turns off after 5 minutes (default) if no keys are pressed. Pressing any key will turn the LCR meter back on after it is powered off automatically.

The **APO** annunciator is shown on the bottom left of the display when the APO function is enabled.

NOTE

- To change the time-out period or completely disable the APO function, refer to [“Changing the auto power-off and backlight time-outs”](#) on page 73.
 - If an external power adapter is used, the APO function will be disabled.
-

Enabling the backlight

If viewing the display becomes difficult in low-light conditions, press  for more than 1 second to activate the LCD backlight.

To conserve battery life, a user-adjustable time-out controls how long the backlight stays on. The default time-out is 30 seconds.

NOTE

- To change the time-out period or completely disable the backlight, refer to [“Changing the auto power-off and backlight time-outs”](#) on page 73.
 - If an external power adapter is used, the backlight time-out will be disabled.
-

Selecting the range

Pressing  switches the LCR meter between manual and autoranging. It also cycles through the available LCR meter ranges when manual ranging is enabled.

Autoranging is convenient because the LCR meter automatically selects an appropriate range for sensing and displaying each measurement. However, manual ranging results in better performance, since the LCR meter does not have to determine which range to use for each measurement.

In autorange, the LCR meter selects the lowest range to display the highest available precision (resolution) for the input signal. If manual range is already enabled, press  for more than 1 second to enter the autoranging mode.

If autoranging is enabled, press  to enter the manual range mode.

Each additional press of  sets the LCR meter to the next higher range, unless it is already in the highest range, at which point the range switches to the lowest range.

Adjusting the tilt stand

To adjust the LCR meter to a 60° standing position, pull the tilt-stand outward to its maximum reach.

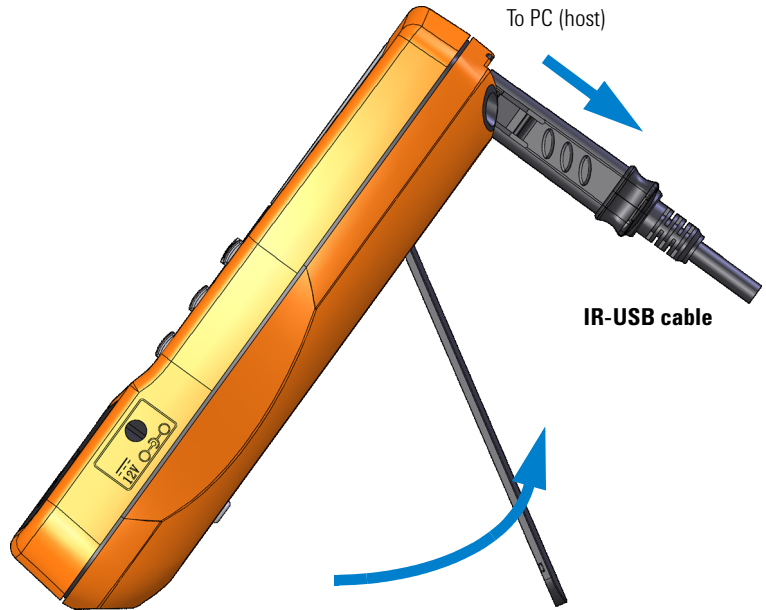

Figure 1-3 Tilt-stand adjustment and IR cable connection

Connecting the IR-USB cable

You can use the IR communication link (IR communication port, located at the rear panel) and the Agilent GUI Data Logger software to control your LCR meter remotely. Hence, you can only perform data logging operations in the Agilent GUI Data Logger application with the LCR meter connected via the USB-IR cable to the PC.

Ensure that the Agilent logo on the U5481A IR-USB cable (purchased separately) connected to the LCR meter is facing up. Firmly push the IR head into the LCR meter's IR communication port until it snaps into place (see [Figure 1-3](#)).

Refer to the *Agilent GUI Data Logger Software Quick Start Guide and Help* for more information on the IR communication link and the Agilent GUI Data Logger software.

Time	Mode	Freq	Lp	La	Cp	Cr	Rp	Ra	Z	DCR	ESR	Q	DF	Theta
3/4/2011 3:50:33 PM	Ra	100.0	-	-	-	-	-	107.0 G	-	-	-	55.78 μ	99.00E+036	44.38
3/4/2011 3:50:34 PM	Ra	100.0	-	-	-	-	-	16.59 G	-	-	-	916.5 μ	99.00E+036	43.79
3/4/2011 3:50:34 PM	Ra	100.0	-	-	-	-	-	8.758 G	-	-	-	916.5 μ	99.00E+036	43.79
3/4/2011 3:50:35 PM	Ra	100.0	-	-	-	-	-	9.979 G	-	-	-	80.28 μ	99.00E+036	2.847
3/4/2011 3:50:35 PM	Ra	100.0	-	-	-	-	-	19.94 G	-	-	-	365.3 μ	99.00E+036	97.69
3/4/2011 3:50:36 PM	Ra	100.0	-	-	-	-	-	13.55 G	-	-	-	398.0 μ	99.00E+036	21.59
3/4/2011 3:50:36 PM	Ra	100.0	-	-	-	-	-	29.34 G	-	-	-	229.7 μ	99.00E+036	17.09
3/4/2011 3:50:37 PM	Ra	100.0	-	-	-	-	-	8.009 G	-	-	-	1.007 m	993.0	44.88
3/4/2011 3:50:37 PM	Ra	100.0	-	-	-	-	-	9.306 G	-	-	-	629.4 μ	99.00E+036	15.45
3/4/2011 3:50:38 PM	Ra	100.0	-	-	-	-	-	19.90 G	-	-	-	629.4 μ	99.00E+036	93.91
3/4/2011 3:50:38 PM	Ra	100.0	-	-	-	-	-	7.717 G	-	-	-	201.2 μ	99.00E+036	14.87
3/4/2011 3:50:39 PM	Ra	100.0	-	-	-	-	-	6.840 G	-	-	-	933.3 μ	99.00E+036	33.52
3/4/2011 3:50:39 PM	Ra	100.0	-	-	-	-	-	7.646 G	-	-	-	817.7 μ	99.00E+036	31.90
3/4/2011 3:50:40 PM	Ra	100.0	-	-	-	-	-	8.018 G	-	-	-	216.6 μ	99.00E+036	4.012
3/4/2011 3:50:41 PM	Ra	100.0	-	-	-	-	-	6.741 G	-	-	-	757.8 μ	99.00E+036	36.96
3/4/2011 3:50:41 PM	Ra	100.0	-	-	-	-	-	11.91 G	-	-	-	914.1 μ	99.00E+036	69.67
3/4/2011 3:50:42 PM	Ra	100.0	-	-	-	-	-	10.85 G	-	-	-	139.9 μ	99.00E+036	17.03
3/4/2011 3:50:42 PM	Ra	100.0	-	-	-	-	-	33.92 G	-	-	-	10.78 μ	99.00E+036	23.94
3/4/2011 3:50:43 PM	Ra	100.0	-	-	-	-	-	7.512 G	-	-	-	449.4 μ	99.00E+036	13.96
3/4/2011 3:50:43 PM	Ra	100.0	-	-	-	-	-	27.26 G	-	-	-	131.4 μ	99.00E+036	45.67
3/4/2011 3:50:44 PM	Ra	100.0	-	-	-	-	-	9.799 G	-	-	-	1.068 m	936.3	66.81

Figure 1-4 Agilent GUI Data Logger Software

The Agilent GUI Data Logger software and its supporting documents (*Quick Start Guide* and *Help*) are available for free download at <http://www.agilent.com/find/hhTechLib>.







You may purchase a U5481A IR-USB cable from an Agilent Sales Office nearest to you.

Power-on options

Some options can be selected only while you turn the LCR meter on. These power-on options are listed in the table below.

To select a power-on option, press and hold the specified key in [Table 1-2](#) while turning the LCR meter ON (☺).

Table 1-2 Power-on options

Key	Description
	Tests the LCD. All annunciators are displayed in the LCD. Press any key to exit this mode.
	Simulates the Auto Power-Off (APO) mode. Press any key to turn the LCR meter back on and resume normal operation.
	Checks the firmware version. The LCR meter's firmware version will be shown on the primary display. Press any key to exit this mode.
	Performs the Open/Short CAL on all frequencies and all ranges for the User mode (OS-User). ^[1]
	Enters the Setup menu. See Chapter 3 , "Setup Options," starting on page 51 for more information. Press and hold  for more than 1 second to exit this mode.

[1] The Open/Short CAL requires approximately 1.5 minutes to complete.

Your LCR Meter in Brief

Dimensions

Front view



Figure 1-5 Width dimensions

Rear and side view

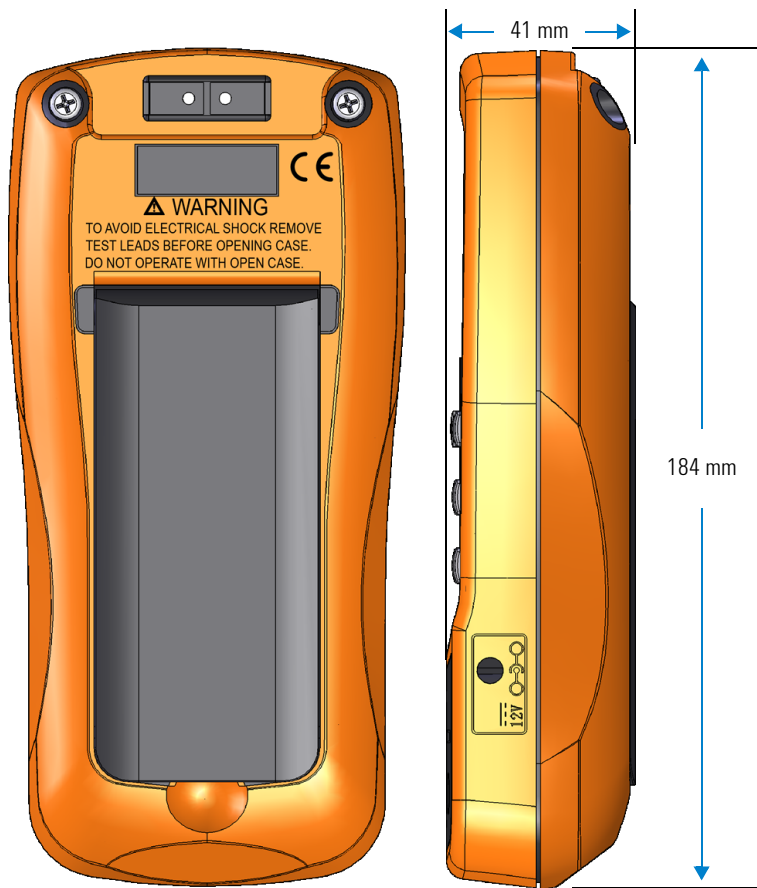

Figure 1-6 Height and depth dimensions

Overview

Front panel

The front panel parts of your LCR meter are described in this section. Click the respective “Learn more” pages in [Table 1-3](#) for more information on each part.



Figure 1-7 Front panel

Table 1-3 Front panel parts

Legend	Description	Learn more on:
1	Display screen	page 18
2	Keypad	page 15
3	Input terminals and sockets	page 22

Rear panel

The rear panel parts of your LCR meter are described in this section. Click the respective “Learn more” pages in [Table 1-4](#) for more information on each part.

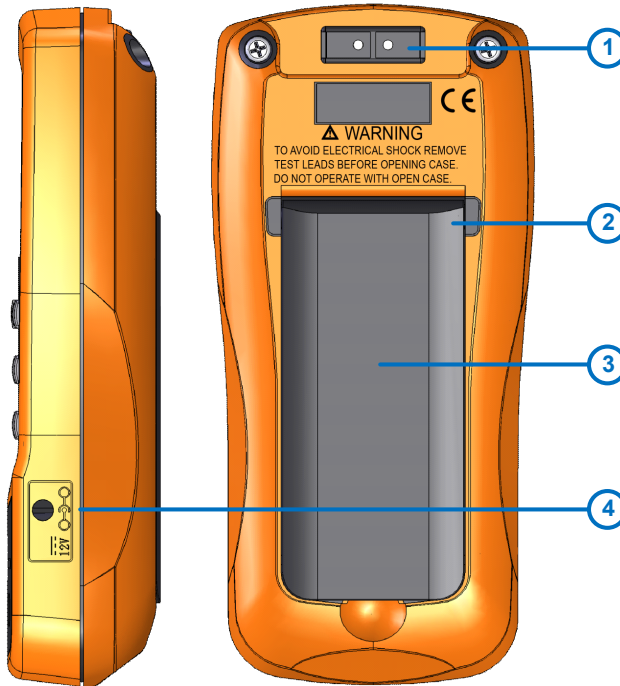

Figure 1-8 Rear panel

Table 1-4 Rear panel parts

Legend	Description	Learn more on:
1	IR communication port	page 9
2	Tilt stand	page 8
3	Battery cover (lift the tilt stand for access)	page 3
4	External power adapter input jack ^[1]	-









[1] The external power adapter input jack requires an input voltage of +12 VDC.

Keypad

The operation of each key is explained below. Pressing a key enables a function, displays a related annunciator, and emits a beep.

Each key operation of the U1731C/U1732C/U1733C keypad (shown in [Figure 1-7](#)) is described in [Table 1-5](#). Click the respective “Learn more” pages in [Table 1-5](#) for more information on each function.

Table 1-5 Keypad functions

Legend	Function when pressed for:		Learn more on:
	Less than 1 second	More than 1 second	
	Turns the LCR meter on or off.	-	page 5
 ESR	Starts or stops the auto identification mode. <ul style="list-style-type: none"> Press  again while the AI annunciator is shown to exit this mode. 	Enables or disables the ESR (equivalent series resistance) mode. <ul style="list-style-type: none"> Press  for more than 1 second to exit this mode. The LCR meter will return to capacitance measurement by default. 	page 26
	Holds or releases the present reading on the display. <ul style="list-style-type: none"> Press  again to update the reading automatically once it is stable. Press  for more than 1 second to exit this mode. 	Starts or stops the static recording mode. <ul style="list-style-type: none"> Press  again to cycle through the maximum (Max), minimum (Min), average (Avg), and present (MaxMinAvg) readings. Press  for more than 1 second to exit this mode. 	page 40

1 Introduction

Your LCR Meter in Brief

Table 1-5 Keypad functions (continued)



















Legend	Function when pressed for:		Learn more on:
	Less than 1 second	More than 1 second	
	<p>Switches between the dissipation factor (D), quality factor (Q), or phase angle (θ) measurement.</p>	<p>Enables or disables the limit comparison mode.</p> <ul style="list-style-type: none"> While the Limit annunciator is flashing, <ul style="list-style-type: none"> press  and  again to toggle between high (H) or low (L) limits, then use the  and  keys to select a high/low limit set (1 to 16). Press  to start the limit sorting (with the selected limit set), or If no activity is detected after 3 seconds, the limit comparison will begin. Press  for more than 1 second to exit this mode. 	<p>page 37 and page 42</p>
	<p>Selects a test frequency.</p> <ul style="list-style-type: none"> Press  again to cycle through the various test frequencies (100 Hz to 100 kHz). 	<p>U1733C only: Enables or disables the DCR (direct current resistance) mode.</p> <ul style="list-style-type: none"> Press  for more than 1 second to exit this mode. The LCR meter will return to inductance measurement by default. 	<p>page 37</p>
	<p>Disables autoranging and sets a manual range.</p> <ul style="list-style-type: none"> Press  again to cycle through each available measurement range. 	<p>Enables autoranging.</p>	<p>page 7</p>
	<p>Switches between impedance (Z), inductance (L), capacitance (C), and resistance (R) measurement.</p>	<p>Toggles between parallel and series circuit mode.</p>	<p>page 27 to page 35 and page 37</p>
	<p>Sets the tolerance mode.</p> <ul style="list-style-type: none"> Connect/insert an appropriate component into the input terminals/sockets and press  to set the value shown on the secondary display as the standard reference value. Press  again to cycle through the various tolerance values (1% to 20%). 	<p>Turns the LCD backlight on for 15 seconds (default) or off.</p> <ul style="list-style-type: none"> To change the backlight time-out refer to “Changing the auto power-off and backlight time-outs” on page 73. 	<p>page 38 and page 6</p>

Table 1-5 Keypad functions (continued)

Legend	Function when pressed for:		Learn more on:
	Less than 1 second	More than 1 second	
	<p>Sets the null/relative mode.</p> <ul style="list-style-type: none"> The displayed value is saved as a reference to be subtracted from subsequent measurements. Press  again to cancel the null mode. 	<p>Enters the open/short calibration mode for the selected range and test frequency.</p> <ul style="list-style-type: none"> Follow the prompts on the screen (open or short connector) and press  to begin the calibration process. The LCR meter will return to normal display when the calibration is complete. 	<p>page 45 and page 46</p>

Display screen

The function that each display annunciator of your LCR meter is associated to is described in this section. See also “[Measurement units](#)” on page 21 for a list of available measurement signs and notations.

General display annunciators

The general display annunciators of your LCR meter are described in the table below.

Each display annunciator of the U1731C/U1732C/U1733C display screen (shown in [Figure 1-7](#)) is described in [Table 1-6](#). Click the respective “Learn more” pages in [Table 1-6](#) for more information on each annunciator.

Table 1-6 General annunciators

Legend	Description	Learn more on:
	Remote control via PC indicator	page 9
ESR	Equivalent series resistance indicator	
DCR	Resistance measurement by direct current indicator	
OS-Factory	LCR meter using open/short CAL settings by factory	page 46
OS-User	LCR meter using open/short CAL setting by user	
100Hz	Measuring frequency of test signal is 100 Hz	
120Hz	Measuring frequency of test signal is 120 Hz	
1kHz	Measuring frequency of test signal is 1 kHz	page 37
10kHz	Measuring frequency of test signal is 10 kHz	
100kHz	Measuring frequency of test signal is 100 kHz	

Table 1-6 General annunciators (continued)





Legend	Description	Learn more on:
Tol	Tolerance mode indicator for sorting L, C, or R	
1%	Tolerance set to 1% for sorting capacitance	
5%	Tolerance set to 5% for sorting capacitance	page 38
10%	Tolerance set to 10% for sorting capacitance	
20%	Tolerance set to 20% for sorting capacitance	
Hold	Data hold mode indicator	page 40
•))	Audible alert indicator for tolerance or limit mode	page 71
D	Dissipation factor indicator	
Q	Quality factor indicator	page 37
θ	Phase angle of impedance indicator	
	Secondary display	-
° % kHz	Measurement units for the secondary display	page 21
Z	Impedance measurement indicator	page 35
L	Inductance measurement indicator	page 29
C	Capacitance measurement indicator	page 31
R	Resistance measurement indicator	page 33

Table 1-6 General annunciators (continued)

Legend	Description	Learn more on:
MaxMinAvg	Present reading shown on primary display	
Max	Maximum reading shown on primary display	page 40
Min	Minimum reading shown on primary display	
Avg	Averaged reading shown on primary display	
Δ	Relative (Null) indicator	page 45
Auto	Autoranging indicator	page 7
Limit	Limit mode indicator	
\blacktriangle	Reading out of HI limit	page 42
\blacktriangledown	Reading out of LO limit	
APO	Auto power-off indicator	page 6
-18888	Primary display	-
PrpFH MkQS	Measurement units for the primary display	page 21
P 	Parallel mode indicator	page 37
S 	Series mode indicator	
	Battery capacity indicator	page 5

Measurement units

The available signs and notations for each measurement function in your LCR meter are described in [Table 1-7](#). The units listed below are applicable to the primary display measurements of your LCR meter.

Table 1-7 Measurement units display

Sign/Notation	Description
M	Mega 1E+06 (1000000)
k	kilo 1E+03 (1000)
m	milli 1E-03 (0.001)
μ	micro 1E-06 (0.000001)
n	nano 1E-09 (0.000000001)
p	pico 1E-12 (0.000000000001)
°	Degree, unit for phase angle measurement
%	Percentage, unit for tolerance measurement
μH, mH, H	Henry, units for inductance measurement
pF, nF, μF, mF	Farad, units for capacitance measurement
Ω, kΩ, MΩ	Ohm, units for resistance and impedance measurement
kHz, Hz	Hertz, units for frequency measurement







Input terminals

The terminal and socket connections of your LCR meter are described in the table below.

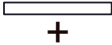
WARNING

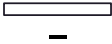
To avoid damaging this instrument, do not exceed the input limit. Do not apply voltage to input terminals. Discharge the capacitor before testing.

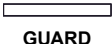
Table 1-8 Input terminal/socket connections

Input terminal/socket	Description
 	Positive terminal/component socket
 	Negative terminal/component socket
 	Guard terminal/component socket

Cleaning Your LCR Meter

WARNING

To avoid electrical shock or damage to the LCR meter, ensure that the insides of the casing stay dry at all times.

Dirt or moisture in the terminals can distort readings. Follow the steps below to clean your LCR meter.

- 1 Turn the LCR meter off and remove the test leads.
- 2 Turn the LCR meter over and shake out any dirt that may have accumulated in the terminals.
- 3 Wipe the case with a damp cloth and mild detergent – do not use abrasives or solvents.
- 4 Wipe the contacts in each terminal with a clean swab dipped in alcohol.

1 Introduction
Cleaning Your LCR Meter

THIS PAGE HAS BEEN INTENTIONALLY LEFT BLANK.

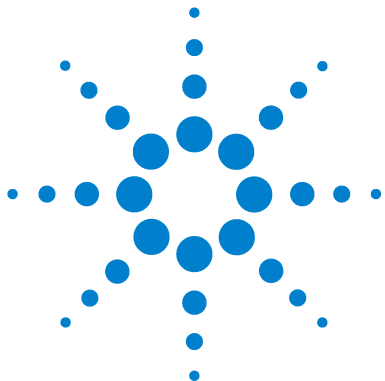

2 Features and Functions

Making Measurements	26
Auto Identification (Ai) function	26
Measuring inductance (L)	29
Measuring capacitance (C)	31
Measuring resistance (R)	33
Measuring impedance (Z)	35
Measuring dissipation factor/quality factor/phase angle (D/Q/ θ)	37
Changing the test frequency	37
Selecting parallel/series circuit mode (P/S)	37
Setting the standard reference tolerance (Tol%)	38
Enabling ESR measurements	39
Enabling DCR measurements	39
Additional Features	40
Freezing the display (Hold)	40
Enabling the static recording mode (Rec)	40
Setting the high/low limit comparison (Limit)	42
Making relative measurements (Null)	45
Performing the open/short CAL	46

This chapter provides detailed information on the features and functions that are available in your LCR meter.



Making Measurements

Auto Identification (Ai) function

Press  to automatically identify the appropriate measurement required for the device-under-test (DUT).

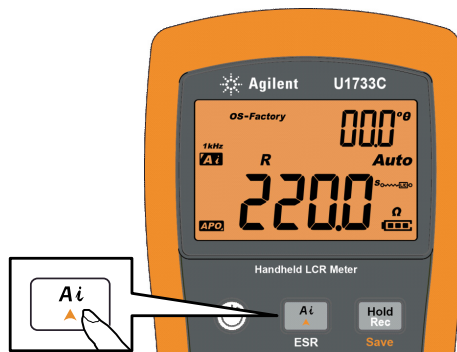



Figure 2-1 Using the Ai function

The  annunciator will flash while the LCR meter identifies the DUT, and

- selects an appropriate measurement in the primary display (L, C, or R) and secondary display (D, Q, or θ),
- selects an appropriate range, and
- selects an appropriate measuring mode (series or parallel).

NOTE

The Ai function helps to identify L, C, and R measurements automatically according to the angle of impedance detected in the DUT. See [Table 2-1](#) for the phase angle rules.

The default phase angle condition is set to 10°. You can change this angle in the Setup menu from 5° to 45°. See [“Changing the Ai function’s phase angle condition”](#) on page 63 for more information.

The measurement mode (series or parallel) will be automatically identified from the autoranging direction.

Table 2-2, Table 2-3, and Table 2-4 list down the series/parallel rules used.

Table 2-1 Auto identification phase angle rules

Phase angle ^[1]	Primary display	Secondary display
$-\text{Set} < \theta < +\text{Set}$	R	θ
$\theta \geq +\text{Set}$	L	Q
$\theta \leq -\text{Set}$	C	D

[1] Where $\pm\text{Set}$ is the phase angle selected.

Table 2-2 Auto identification series/parallel rules for resistance measurements

Resistance range	Down range	Up range
200 M Ω	Parallel	Parallel
20 M Ω	Parallel	Parallel
2000 k Ω	Parallel	Parallel
200 k Ω	Parallel	Parallel
20 k Ω	Parallel	Series
2000 Ω	Parallel	Series
200 Ω	Parallel	Series
20 Ω	Series	Series
2 Ω	Series	Series

2 Features and Functions

Making Measurements

Table 2-3 Auto identification series/parallel rules for capacitance measurements

Range	100 Hz		120 Hz		1 kHz		10 kHz		100 kHz	
	Down	Up	Down	Up	Down	Up	Down	Up	Down	Up
20 mF	Series	Series	Series	Series	-	-	-	-	-	-
2000 μ F	Series	Series	Series	Series	Series	Series	-	-	-	-
200 μ F	Series	Series	Series	Series	Series	Series	Series	Series	-	-
20 μ F	Series	Parallel	Series	Parallel	Series	Series	Series	Series	Series	Series
2000 nF	Series	Parallel	Series	Parallel	Series	Parallel	Series	Series	Series	Series
200 nF	Series	Parallel	Series	Parallel	Series	Parallel	Series	Parallel	Series	Series
20 nF	Parallel	Parallel	Parallel	Parallel	Series	Parallel	Series	Parallel	Series	Parallel
2000 pF	Parallel	Parallel	Parallel	Parallel	Parallel	Parallel	Series	Parallel	Series	Parallel
200 pF	-	-	-	-	Parallel	Parallel	Parallel	Parallel	Series	Parallel
20 pF	-	-	-	-	-	-	Parallel	Parallel	Parallel	Parallel

Table 2-4 Auto identification series/parallel rules for inductance measurements





Range	100 Hz		120 Hz		1 kHz		10 kHz		100 kHz	
	Down	Up	Down	Up	Down	Up	Down	Up	Down	Up
2000 H	Parallel	Parallel	Parallel	Parallel	Parallel	Parallel	-	-	-	-
200 H	Parallel	Parallel	Parallel	Parallel	Parallel	Parallel	Parallel	Parallel	-	-
20 H	Parallel	Series	Parallel	Series	Parallel	Parallel	Parallel	Parallel	Parallel	Parallel
2000 mH	Parallel	Series	Parallel	Series	Parallel	Series	Parallel	Parallel	Parallel	Parallel
200 mH	Parallel	Series	Parallel	Series	Parallel	Series	Parallel	Series	Parallel	Parallel
20 mH	Series	Series	Series	Series	Parallel	Series	Parallel	Series	Parallel	Series
2000 μ H	Series	Series	Series	Series	Series	Series	Parallel	Series	Parallel	Series
200 μ H	-	-	-	-	Series	Series	Series	Series	Parallel	Series
20 μ H	-	-	-	-	-	-	Series	Series	Series	Series

Measuring inductance (L)

Set up your LCR meter to measure inductance as shown in Figure 2-3.

NOTE

It is recommended that you perform the Open/Short calibration (see page 46) before testing to achieve optimum precision for all inductance, capacitance, and resistance measurements at either the highest or lowest ranges.

- 1 Press  to power on the LCR meter.
- 2 Press  to select a suitable test frequency, and
 - i press  to enable the auto identification function; or
 - ii alternatively press  to select inductance measurement.

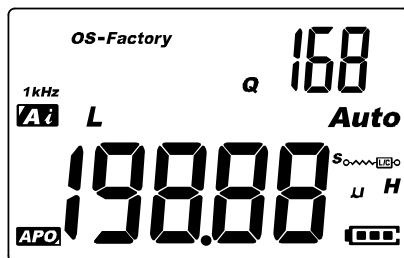



Figure 2-2 Inductance measurement with Q factor

- 3 Insert an inductor into the component socket or connect the test clip to the component leads as required.
- 4 Press  to change the secondary display measurement (D, Q, or θ).
- 5 Read the displays.

2 Features and Functions

Making Measurements

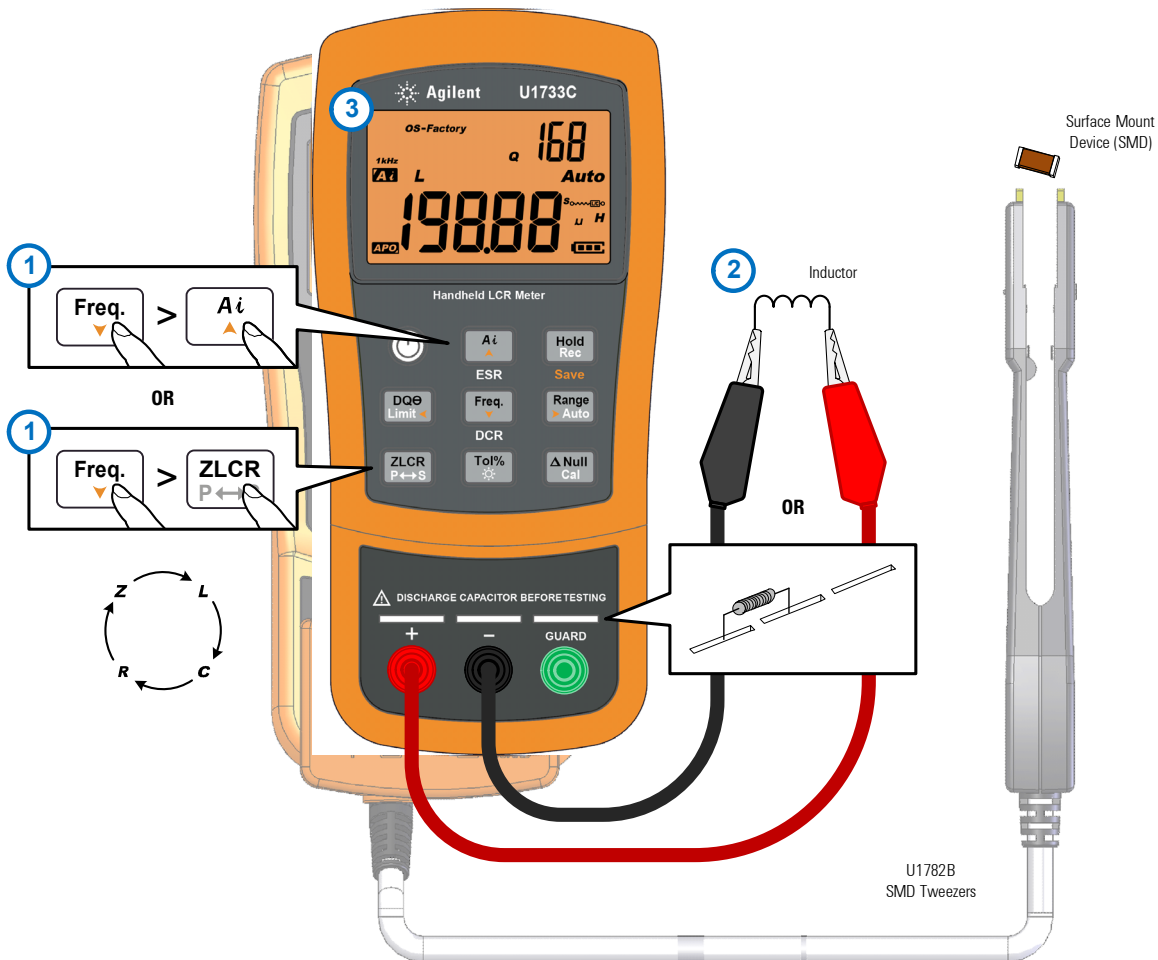





Figure 2-3 Measuring inductance

Measuring capacitance (C)

Set up your LCR meter to measure capacitance as shown in Figure 2-5.

WARNING

To avoid electrical hazards, discharge the capacitor to be tested before measuring.

- 1 Press  to power on the LCR meter.
- 2 Press  to select a suitable test frequency, and
 - i press  to enable the auto identification function; or
 - ii alternatively press  to select capacitance measurement.

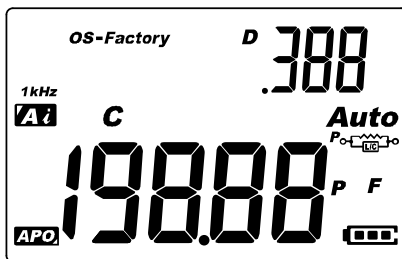



Figure 2-4 Capacitance measurement with D factor

- 3 Insert a capacitor into the component socket or connect the test clip to the component leads as required.
- 4 Press  to change the secondary display measurement (D, Q, or θ).
- 5 Read the displays.

2 Features and Functions

Making Measurements

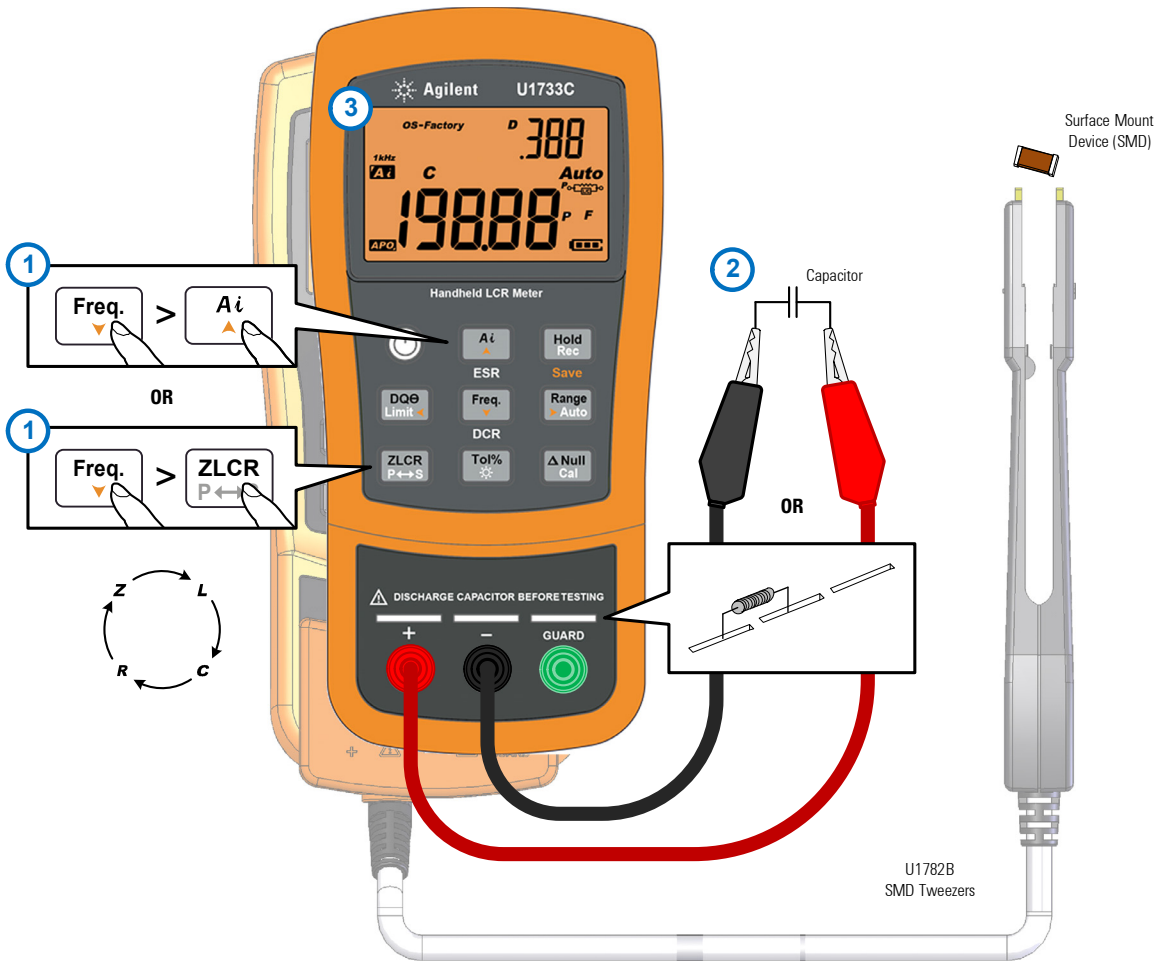





Figure 2-5 Measuring capacitance

Measuring resistance (R)

Set up your LCR meter to measure resistance as shown in Figure 2-7.

CAUTION

To avoid possible damage to your LCR meter or to the equipment under test, disconnect the circuit power and discharge all high-voltage capacitors before measuring resistance.

- 1 Press  to power on the LCR meter.
- 2 Press  to select a suitable test frequency, and
 - i press  to enable the auto identification function; or
 - ii alternatively press  to select resistance measurement.

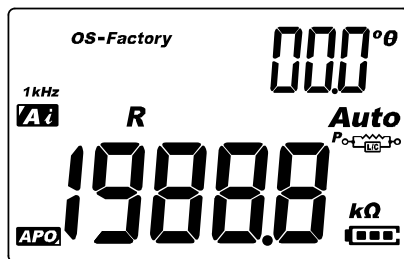

Figure 2-6 Resistance measurement

- 3 Insert a resistor into the component socket or connect the test clip to the component leads as required.
- 4 Read the display.

2 Features and Functions

Making Measurements

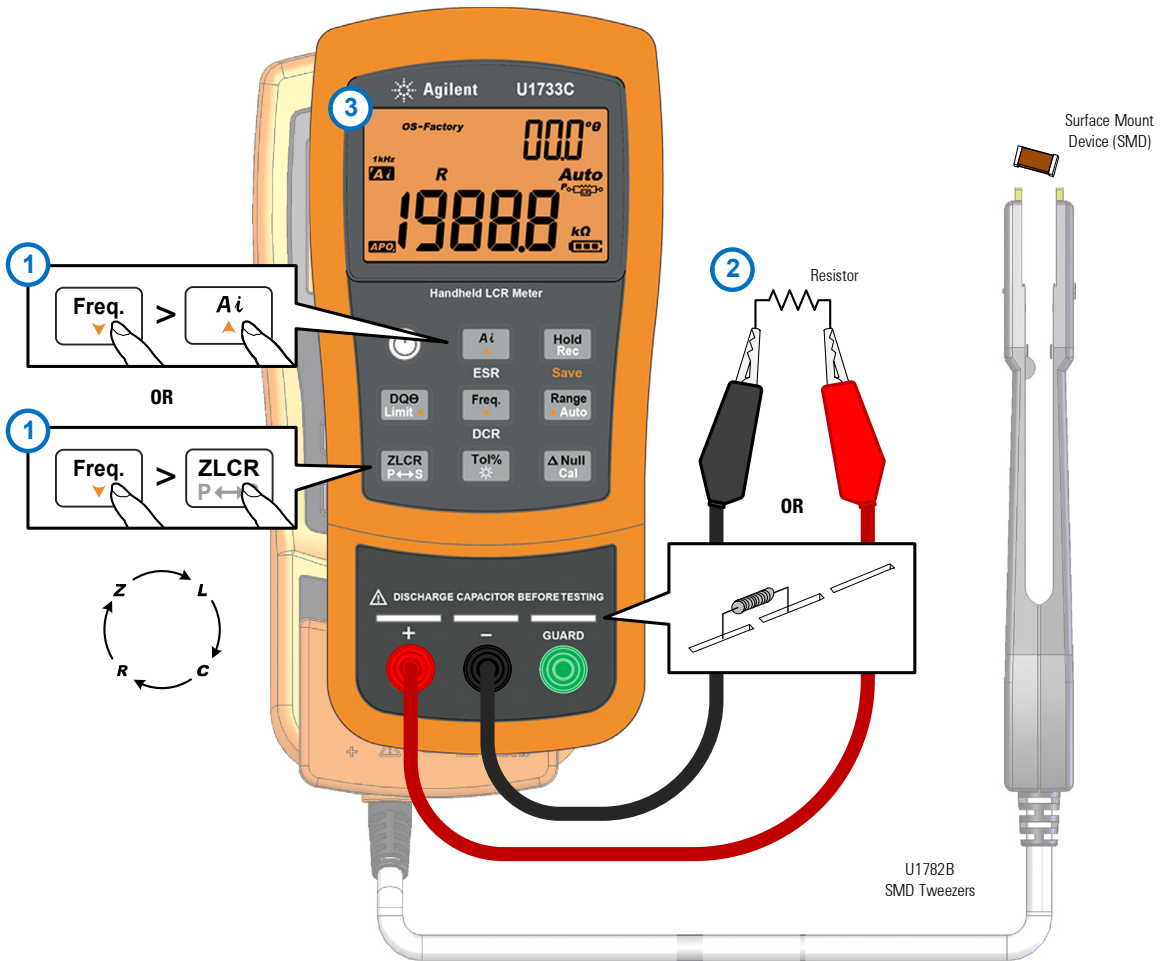

Figure 2-7 Measuring resistance



Measuring impedance (Z)

All circuit components, resistors, capacitors, and inductors have parasitic components. These include, for example, unwanted resistance in capacitors, unwanted capacitance in inductors, and unwanted inductance in resistors. Thus, simple components should be modeled as complex impedances.

Set up your LCR meter to measure impedance as shown in Figure 2-9.

NOTE

To learn more about impedance measurement theories, refer to the *Impedance Measurement Handbook*. This document can be downloaded from our website at <http://www.agilent.com/find/lcrmeters>.

- 1 Press  to power on the LCR meter.
- 2 Press  to select a suitable test frequency, and press  to select impedance measurement.

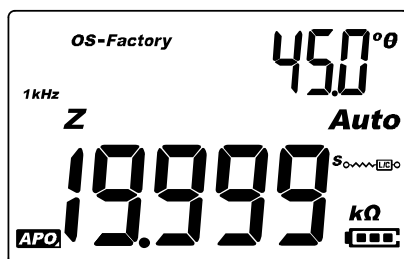

Figure 2-8 Impedance measurement with theta

- 3 Insert a component into the component socket or connect the test clip to the component leads as required.

2 Features and Functions

Making Measurements

- 4 Press **DQE Limit** to change the secondary display measurement (D, Q, or θ).
- 5 Read the displays.

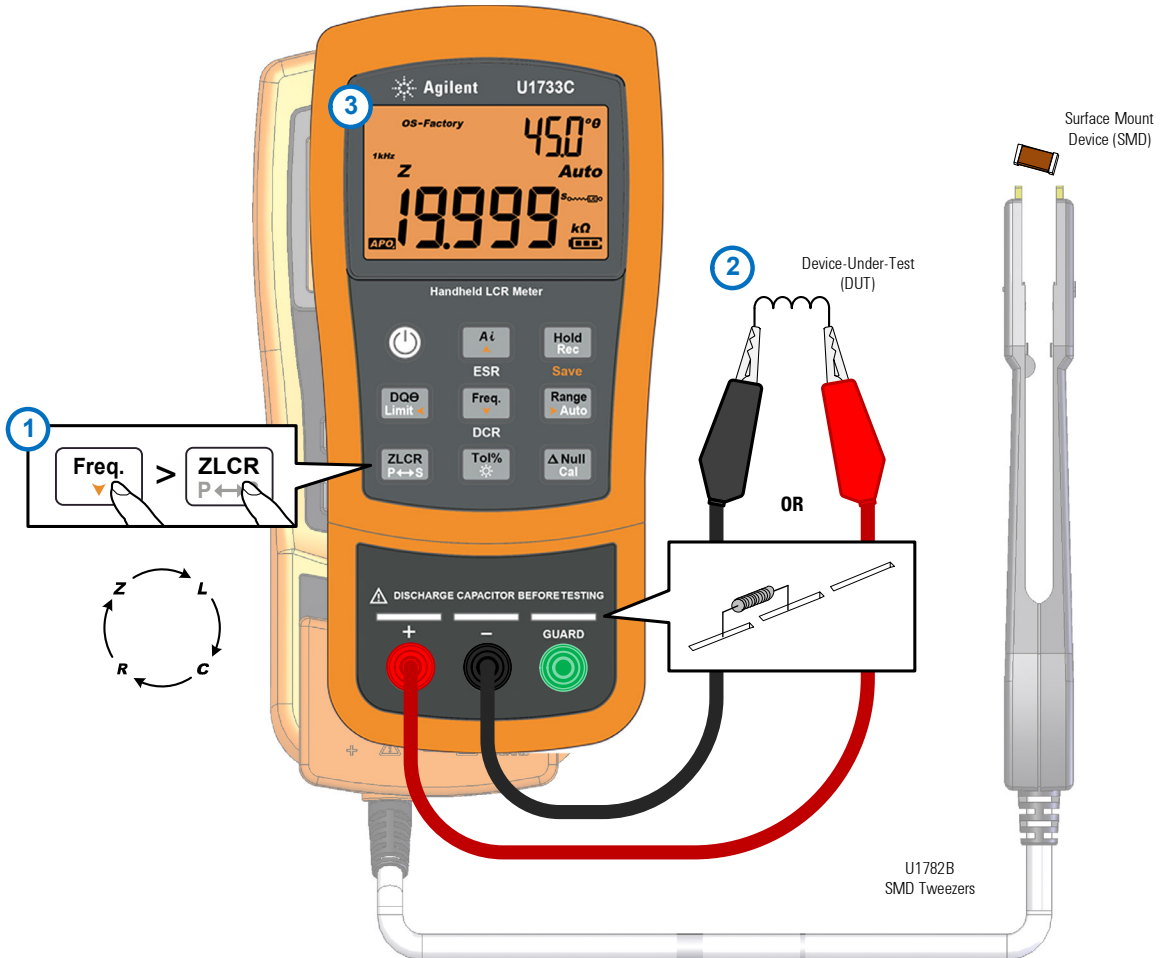



Figure 2-9 Measuring impedance

Measuring dissipation factor/quality factor/phase angle (D/Q/ θ)

The dissipation factor (D), quality factor (Q), and phase angle (θ) values can be displayed interchangeably by pressing the  key when the LCR meter is set to the inductance, capacitance, or impedance measurement mode.

This setting is not applicable for DCR measurement.

Changing the test frequency





The test frequency is set to 1 kHz by default. Press the  key to select a desired test frequency.

Table 2-5 Available test frequencies

Model	100 Hz	120 Hz	1 kHz	10 kHz	100 kHz
U1731C	✓	✓	✓	-	-
U1732C	✓	✓	✓	✓	-
U1733C	✓	✓	✓	✓	✓

Selecting parallel/series circuit mode (P/S)

The LCR meter can display parallel () or series () mode data for all ranges.

Press the  key for more than 1 second to toggle the parallel and series mode.

Series mode is set as the default setting. You can, however, change this power-on behavior in the Setup menu. See [“Changing the initial power-on behavior”](#) on page 56 for more information on how to change the default measurement mode (parallel or series) for subsequent power cycles.

Setting the standard reference tolerance (Tol%)

The tolerance ranges available are 1%, 5%, 10%, and 20%.

To enable the tolerance mode, insert an appropriate component as a standard value into the component socket or connect the test clip to the component leads, then press the  key to set this value as the standard reference tolerance.

Similarly, any value which appears on the display, such as Hold or Max/Min/Avg (Rec), can be used as a standard value to sort components. Press  again to cycle through 1%, 5%, 10%, and 20% tolerance as desired.

This function is designed for convenient component sorting. The beeper will beep three times whenever the component under test exceeds the setting tolerance. Conversely, when the beeper beeps once, this indicates that the component is within the setting tolerance.

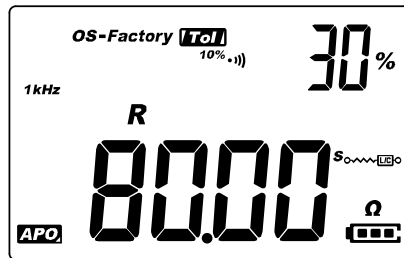



Figure 2-10 Component above setting tolerance

NOTE

- The tolerance mode cannot be activated if Ω is shown on the display or when the tested capacitance value is below 50 counts.
- Tolerance mode is only available in manual ranging; therefore, activation while in autoranging will automatically set the LCR meter to manual ranging.

Enabling ESR measurements

Press  for more than 1 second to select the ESR measurement. Use the ESR measurement to measure the equivalent series resistance of the capacitor, independent of its capacitance.

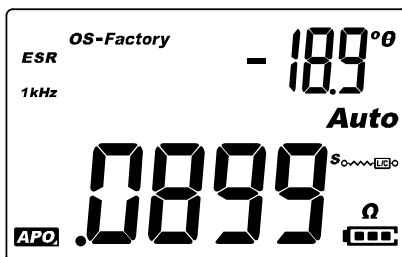



Figure 2-11 ESR measurement with theta

Press  for more than 1 second to exit this mode.

Enabling DCR measurements

Press  for more than 1 second to select the DCR measurement. The DCR measurement measures the resistance of an unknown component by 1 VDC.

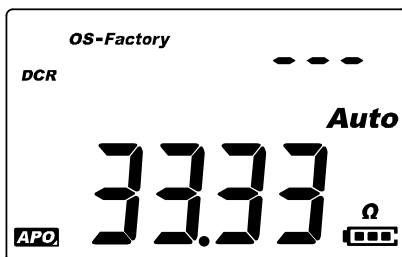



Figure 2-12 DCR measurement

Press  for more than 1 second to exit this mode.

Additional Features

Freezing the display (Hold)

To freeze the display for any function, press the  key. The **Hold** annunciator is shown on the display while the Hold function is active.

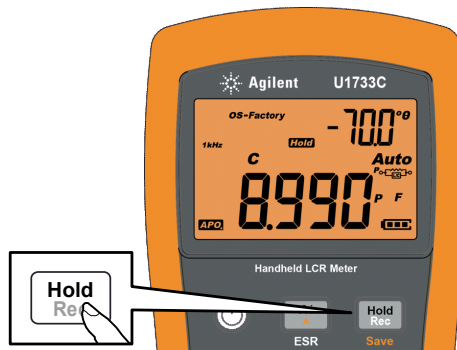



Figure 2-13 Using the Hold function

Press  again to update the reading automatically once it is stable. The **Hold** annunciator flashes while waiting for the reading to be stable.

Press  for more than 1 second to release the Hold function.

Enabling the static recording mode (Rec)

The static recording mode stores the maximum, minimum, and average input values during a series of measurements in the LCR meter's memory.

When the input goes below the recorded minimum value or above the recorded maximum value, the LCR meter beeps and records the new value. The LCR meter also calculates an average of all readings taken since the static recording mode was activated.

From the LCR meter's display, you can view the following statistical data for any set of readings:

- Max: highest reading since the static recording mode was enabled
- Min: lowest reading since the static recording mode was enabled
- Avg: average or mean of all readings since the static recording mode was enabled
- MaxMinAvg: present reading (actual input signal value)

Press the  key for more than 1 second to enter the static recording mode.

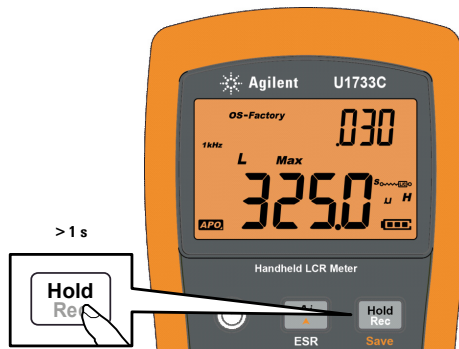



Figure 2-14 Using the Rec function

Press  again to cycle through the Max, Min, Avg, or MaxMinAvg (present) input values.

To exit this mode, press and hold the  key for more than 1 second.

NOTE

- Static recording captures only stable values and updates the memory; it will not record any overload (OL) value for any of the LCR functions. In addition, the LCR meter will not record values below 50 counts in capacitance measurement.
- Static recording is only available in manual ranging; therefore, activation while in autoranging will automatically set the LCR meter to manual ranging.

Setting the high/low limit comparison (Limit)

The high and low limit comparison function helps you to sort components easily. There are 32 limit sets available (16 fixed factory sets, and 16 variable user sets).

The LCR meter will use the factory sets by default. You can set the LCR meter to use the user sets upon start-up from the Setup menu. See “[Changing the power-on limit category and set](#)” on page 65 for more information.

[Table 2-6](#) shows the factory default limit values for each set.

Table 2-6 Factory default high and low limit values

Set	High limit (H)	Low limit (L)
F01	1000	900
F02	1200	1080
F03	1500	1350
F04	1800	1620
F05	2200	1980
F06	2700	2430
F07	3300	2970
F08	3900	3510
F09	4700	4230

Table 2-6 Factory default high and low limit values (continued)

Set	High limit (H)	Low limit (L)
F10	5600	5040
F11	6800	6120
F12	8200	7380
F13	10000	9000
F14	12000	10800
F15	15000	13500
F16	18000	16200

NOTE

The default values of the variable user sets are set to the same as the fixed user sets. Use the Setup menu to change the high and low limits for each set. See “Changing the user high/low limit values” on page 66 for more information.

Press the  key for more than 1 second to activate the high/low limit mode. The last-known set number (H## or L##) will be indicated in the secondary display.

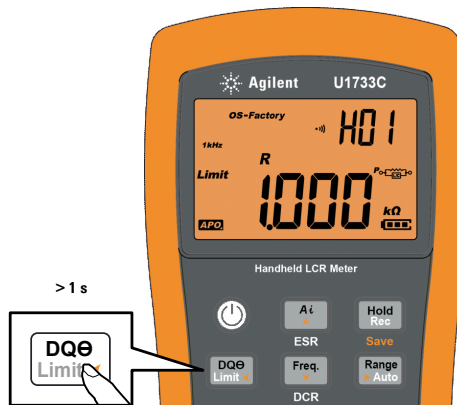





Figure 2-15 Using the Limit function

While the **Limit** annunciator is flashing, use the  or  key to select an appropriate limit set.

You may press  or  again to toggle between the high (H) or low (L) values shown on the primary display.

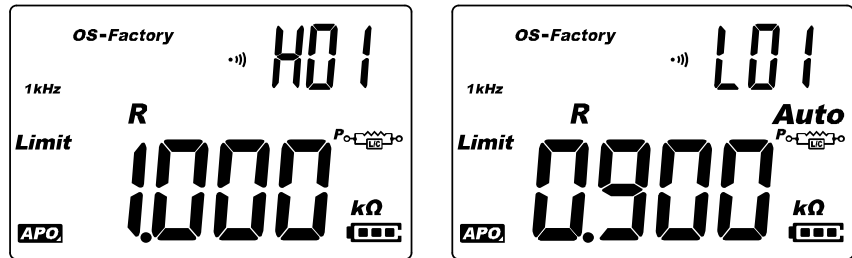



Figure 2-16 High and low limit values

Press  while the **Limit** annunciator is flashing to start the comparison. (If no activity is detected after 3 seconds, the comparison will also begin.)

The LCR meter beeps three times and displays $n\Omega$ in the secondary display if the reading is greater (\blacktriangle) than the high limit or lesser (\blacktriangledown) than the low limit.

If the reading is within the high and low limits, the meter beeps once and displays Ω in the secondary display.

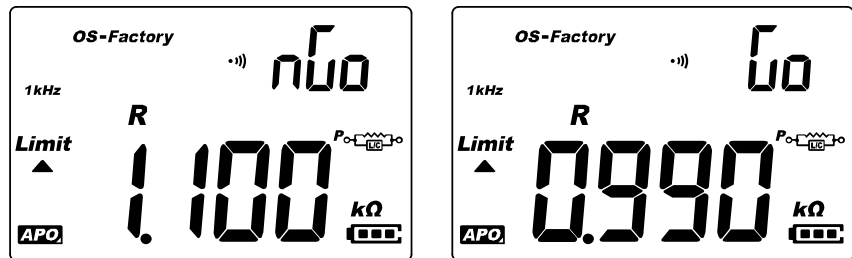



Figure 2-17 nGo and Go indications

The limit set used in the comparison is displayed after the $n\Omega/\Omega$ indication.

Press and hold  for more than 1 second to exit this mode.

Making relative measurements (Null)

When making relative measurements, also called null, each reading is the difference between a stored (selected or measured) relative value and the input signal.

One possible application is to increase the accuracy of a resistance measurement by nulling the test lead resistance (test leads shorted). Nulling the leads is also particularly important prior to making capacitance measurements (test leads open).

Press the  key to enter the relative mode and store the display reading as a reference value. The LCR meter will then display all subsequent readings relative to the reference value.



Figure 2-18 Using the Null function

The Δ annunciator is shown on the display while the relative mode is active. Press  again to exit the relative mode.

NOTE

- The relative mode cannot be activated if the display value is Ω .
- Relative mode is only available in manual ranging; therefore, activation while in autoranging will automatically set the LCR meter to manual ranging.
- The relative mode cannot be activated if the LCR meter is set at auto-ranging with data hold activated.

Performing the open/short CAL

The CAL function offsets (corrects) the LCR meter's internal parameters as well as external connector residues for further measuring. Performing this action will help you to correct the influence for temporary uses.

There are three types of open/short CAL available:

- OS-Factory: Open/Short CAL is performed during factory calibration mode (security code protected). It covers all frequencies and all ranges.
- OS-User: Open/Short CAL is performed at every power-on option interval. It covers all frequencies and all ranges. (see [page 10](#) for the OS-User setup).
- Open/Short CAL for single range and frequency by pressing and holding the  key for more than 1 second.

The corrections for the **OS-Factory** and **OS-User** are pre-stored in the LCR meter. They are both calibrated at the terminal ends.

You can set the LCR meter to start up using the **OS-Factory** or **OS-User** open/short CAL from the Setup menu (see [page 62](#)).

The open/short CAL function is available for fixed measurement ranges.

NOTE

It is highly recommended that open/short CAL be performed before making precision measurements.

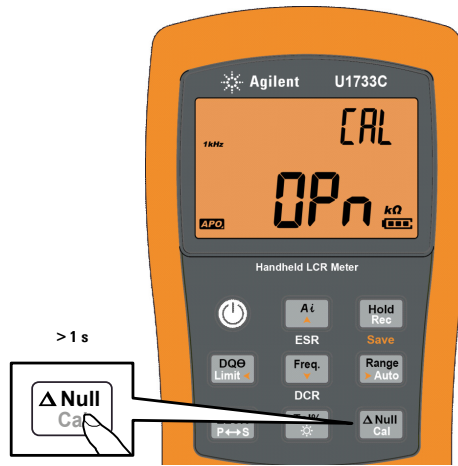

Figure 2-19 Using the Cal function

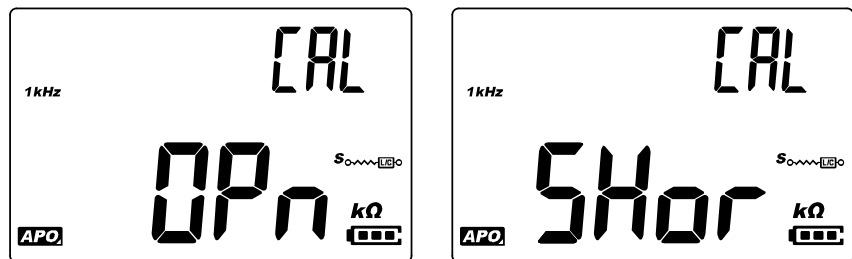



Figure 2-20 Open calibration and short calibration prompts

- 1 Press and hold the  key for more than 1 second to enter the open/short CAL mode for the selected frequency and range.
- 2 Open/Short CAL prompts will be shown on the display. Follow the prompts for open connector (**OPn**) or short connector (**SHor**) connection and press the  key.
The **CAL** annunciator on the upper right of the display will flash indicating that the correction is in process.
- 3 After the open/short CAL is completed, the LCR meter will be restored to the normal display and ready for normal usage.

THIS PAGE HAS BEEN INTENTIONALLY LEFT BLANK.

2 Features and Functions

Additional Features

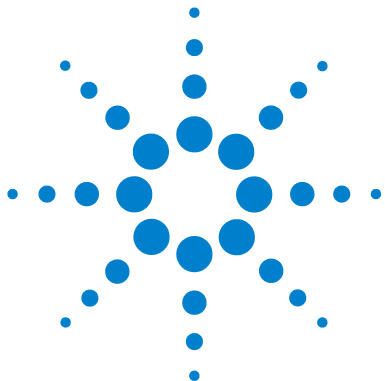

3 Setup Options

Using the Setup Menu	52
Editing numerical values	53
Setup Menu Summary	54
Setup Menu Items	56
Changing the initial power-on behavior	56
Changing the Ai function's phase angle condition	63
Changing the power-on limit category and set	65
Changing the user high/low limit values	66
Changing the baud rate	68
Changing the parity check	69
Changing the data bits	70
Changing the beep frequency	71
Locking the push buttons	72
Changing the auto power-off and backlight time-outs	73
Resetting the Setup items	74

The following chapter describes how to change the preset features of your LCR meter.



















Using the Setup Menu

The Setup menu allows you to change a number of nonvolatile preset features. Modifying these settings affects the general operation of your LCR meter across several functions. Select a setting to edit to perform one of the following:



- Switch between two values, such as on or off.
- Cycle through multiple values from a predefined list.
- Decrease or increase a numerical value within a fixed range.



The contents of the Setup menu are summarized in [Table 3-2](#) on page 54.



Table 3-1 Setup menu key functions



Legend	Description
	<p>Press and hold  while turning the LCR meter ON (Ⓞ) to access the Setup menu.</p> <p>Press and hold  for more than 1 second to exit this mode.</p>
 	<p>Press  or  to step through the menu items.</p>
 	<p>Press  or  at each menu item to change the preset settings. The menu item (in the secondary display) will flash to indicate that you can now change the menu item values.</p> <p>Press  or  again to switch between two values, to cycle through multiple values from a list, or to decrease or increase a numerical value.</p>
 	<p>While the menu item is flashing, press  to save your changes.</p> <p>While the menu item is flashing, press  to discard your changes.</p>



Editing numerical values

When editing numerical values, use the  and  to position the cursor on a numerical digit.

- Press  to move the cursor to the left, and
- Press  to move the cursor to the right.

When the cursor is positioned over a digit, use the  and  keys to change the numerical digit.

- Press  to increment the digit, and
- Press  to decrement the digit.

When you have completed your changes, save the new numerical value by pressing . (Or alternatively, if you wish to discard the changes you made press, .)

Setup Menu Summary

The Setup menu items are summarized in the table below. Click the respective “Learn more” pages for more information on each menu item.

Table 3-2 Setup menu item descriptions

Legend	Available settings	Description	Learn more on:
P_{on} TYPE	<i>Ai</i> , Z, L, C, R, ESR, or DCR	Set the measurement type that the LCR meter powers up in. Default is the auto identification (<i>Ai</i>) mode.	page 56
P_{on} FrEQ	100 Hz, 120 Hz, 1 kHz, 10 kHz, or 100 kHz	Set the test frequency that the LCR meter powers up in. Default is 1 kHz.	page 58
P_{on} ^L Auto	D, Q, or θ and P or S	Set the inductance (L) secondary parameter and measurement mode that the LCR meter powers up in. Default is quality factor (Q) and series (S).	page 59
P_{on} ^C Auto	D, Q, or θ and P or S	Set the capacitance (C) secondary parameter and measurement mode that the LCR meter powers up in. Default is dissipation factor (D) and series (S).	page 60
P_{on} ^R Auto	D, Q, or θ and P or S	Set the resistance (R) secondary parameter and measurement mode that the LCR meter powers up in. Default is phase angle (θ) and series (S).	page 61
σSC FACT	FACT or USEr	Set the open/short CAL mode that the LCR meter powers up in. Default is factory (FACT).	page 62
θ_i IO	05° to 45°	Set the phase angle condition for the auto identification (<i>Ai</i>) mode. Default is 10°.	page 63
P_{on} FL01	Ft01 to Ft16 or Ur01 to Ur16	Set the limit category (factory or user) and set (01 to 16) that the LCR meter powers up in. Default is Ft01.	page 65

Table 3-2 Setup menu item descriptions (continued)

Legend	Available settings	Description	Learn more on:
$H01$ 1000	H01 to H16 or L01 to L16 0 to 19999	Set the high and low limits for each variable user set. See Table 3-4 on page 66 for the user default values.	page 66
bPS 9600	9600 or 19200	Set the baud rate for remote communication with a PC (9600 or 19200). Default is 9600.	page 68
PAR none	En, none, or odd	Set the parity bit for remote communication with a PC (even, none, or odd). Default is none.	page 69
dAt 8bit	7bit or 8bit	Set the data bit length for remote communication with a PC (7-bit or 8-bit). Default is 8-bit.	page 70
bEP 4000	2000 Hz, 3000 Hz, 4000 Hz, or off	Set the LCR meter's beep frequency (2000 Hz, 3000 Hz, 4000 Hz, or off). Default is 4000 Hz.	page 71
LPb off	off or on	Lock the LCR meter's push buttons. Default is off.	page 72
APo 05	01 to 99 mins or off	Set the auto power-off time-out period from 1 to 99 minutes (1 hour, 39 minutes) or off. Default is 5 minutes.	page 73
blt 30	01 to 99 s or off	Set the LCD backlight timeout period from 1 to 99 seconds (1 minute, 39 seconds) or off. Default is 30 seconds.	
rSt dEFA	dEFA	Reset the LCR meter to its factory default settings.	page 74

Setup Menu Items

Changing the initial power-on behavior

You can change the power-on behavior of your LCR meter for subsequent power cycles.

Parameter	Range	Default setting
Pon-tYPE	<i>Ai</i> , Z, L, C, R, ESR, or DCR	<i>Ai</i>
Pon-FrEq	100 Hz, 120 Hz, 1 kHz, 10 kHz, or 100 kHz	1 kHz
Pon-AUto (L)	<ul style="list-style-type: none">• D, Q, or $^{\circ}\theta$• Parallel or Series	<ul style="list-style-type: none">• Q• Series
Pon-AUto (C)	<ul style="list-style-type: none">• D, Q, or $^{\circ}\theta$• Parallel or Series	<ul style="list-style-type: none">• D• Series
Pon-AUto (R)	<ul style="list-style-type: none">• D, Q, or $^{\circ}\theta$• Parallel or Series	<ul style="list-style-type: none">• $^{\circ}\theta$• Series
Pon-oSC	FACT or USEr	FACT

Changing the power-on measurement type

Use this Setup item to change the LCR meter's initial measurement type. You can set the LCR meter to start up in the

- auto identification mode (*Ai*),
- impedance measurement (Z),
- inductance measurement (L),
- capacitance measurement (C),
- resistance measurement (R),
- equivalent series resistance mode (ESR), or
- direct current resistance mode (DCR) for U1733C only

The LCR meter will start up in the selected measurement type for subsequent power cycles.

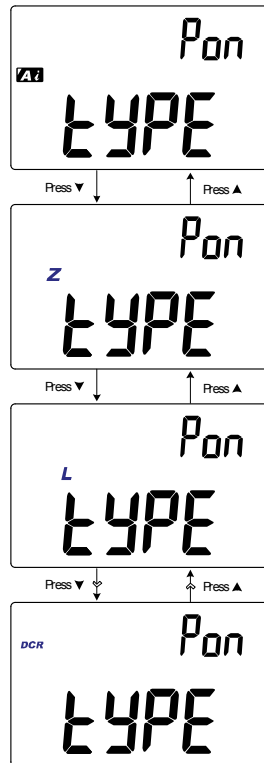

Figure 3-1 Changing the power-on measurement type

Changing the power-on test frequency

Use this Setup item to change the LCR meter's initial test frequency. You can set the LCR meter to start up using a test frequency from 100 Hz to 100 kHz.

The LCR meter will start up using the selected test frequency for subsequent power cycles.

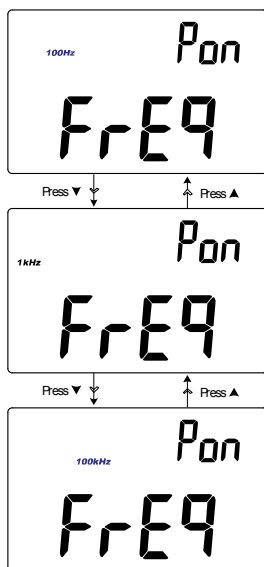

Figure 3-2 Changing the power-on test frequency

Changing the power-on secondary parameter and measurement mode for inductance (L) measurements

Use this Setup item to change the inductance (L) measurement's initial secondary parameter – dissipation factor (D), quality factor (Q), or phase angle (θ) – and measurement mode – parallel or series.

The inductance (L) measurement will start up using the selected secondary parameter and measurement mode for subsequent power cycles.

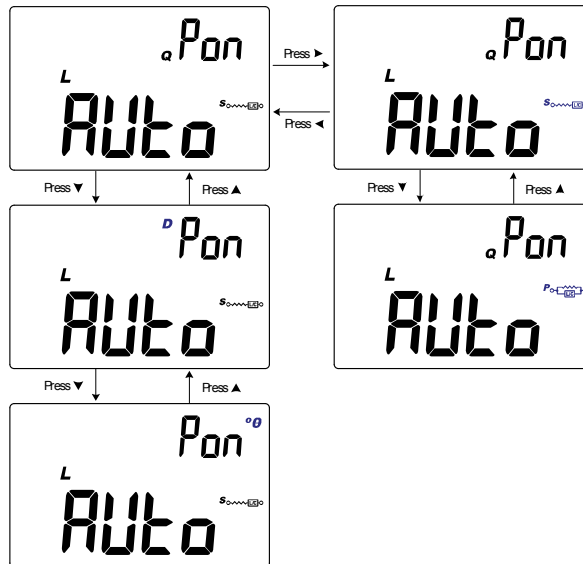

Figure 3-3 Changing the power-on secondary parameter and measurement mode for inductance (L) measurements

Changing the power-on secondary parameter and measurement mode for capacitance (C) measurements

Use this Setup item to change the capacitance (C) measurement's initial secondary parameter – dissipation factor (D), quality factor (Q), or phase angle (θ) – and measurement mode – parallel or series.

The capacitance (C) measurement will start up using the selected secondary parameter and measurement mode for subsequent power cycles.

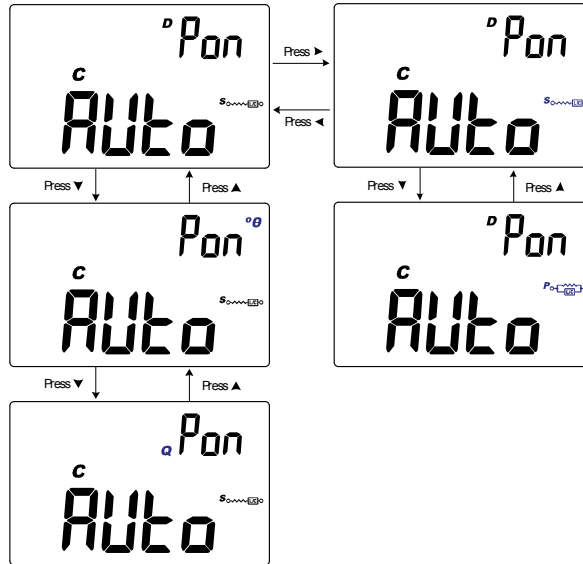

Figure 3-4 Changing the power-on secondary parameter and measurement mode for capacitance (C) measurements

Changing the power-on secondary parameter and measurement mode for resistance (R) measurements

Use this Setup item to change the resistance (R) measurement's initial secondary parameter – dissipation factor (D), quality factor (Q), or phase angle (θ) – and measurement mode – parallel or series.

The resistance (R) measurement will start up using the selected secondary parameter and measurement mode for subsequent power cycles.

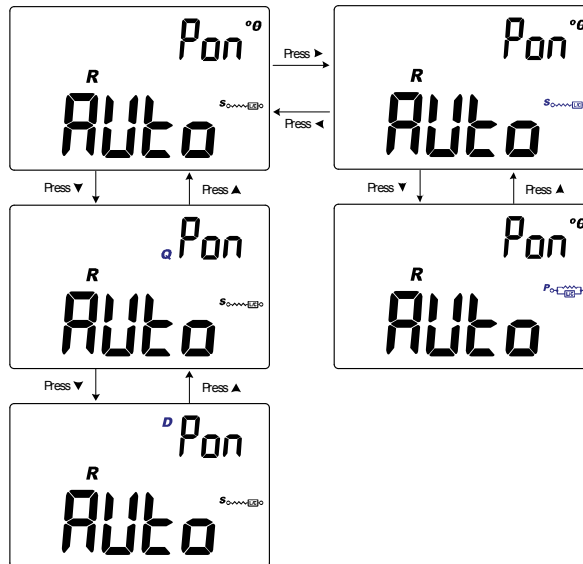

Figure 3-5 Changing the power-on secondary parameter and measurement mode for resistance (R) measurements

Changing the power-on open/short CAL

Use this Setup item to change the LCR meter's initial open/short CAL to either the factory open/short CAL (**FACT**), or user open/short CAL (**USEr**).

The LCR meter will start up using the selected open/short CAL for subsequent power cycles.

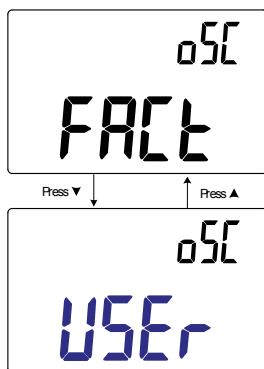

Figure 3-6 Changing the power-on open/short CAL

Changing the *Ai* function's phase angle condition

This setting is used with the *Ai* function (see [page 26](#)). The *Ai* function helps to identify L, C, and R measurements automatically according to the angle of impedance detected in the DUT.

Use this Setup item to change the default phase angle for the *Ai* function between 5° and 45°.

Parameter	Range	Default setting
<i>Ai</i>	(5 to 45)°	10°

[Table 3-3](#) shows the correlation between the phase angle detected and the L, C, and R measurements selected.

Table 3-3 Auto identification phase angle rules

Phase angle ^[1]	Primary display	Secondary display
$-\text{Set} < \theta < +\text{Set}$	R	θ
$\theta \geq +\text{Set}$	L	Q
$\theta \leq -\text{Set}$	C	D

[1] Where $\pm\text{Set}$ is the phase angle selected.

3 Setup Options

Setup Menu Items

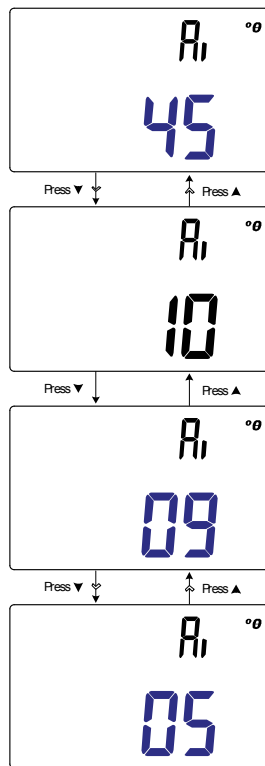

Figure 3-7 Changing the A_i function's phase angle condition

Changing the power-on limit category and set

This setting is used with the Limit comparison function (page 42). There are 32 limit sets available (16 fixed factory sets, and 16 variable user sets).

Use this Setup item to change the default category (factory or user) and set (1 to 16) for subsequent power cycles.

Parameter	Range	Default setting
Pon	<ul style="list-style-type: none"> Factory (Ft01 to Ft16) or User (Ur01 to Ur16) 	Ft01

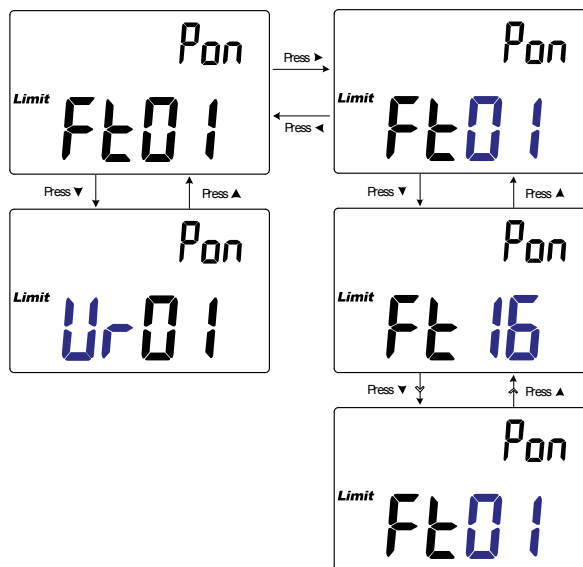

Figure 3-8 Changing the power-on limit and category set

Changing the user high/low limit values

This setting is used with the Limit comparison function (page 42). There are 16 variable user sets available.

Use this Setup item to change the high and low limits of each variable user set.

NOTE

The low limit can be set from 0 to less than or equal to the high limit, and the high limit can be set from more than or equal to the low limit to less than or equal to the maximum display count (19999).

Parameter	Range	Default setting
<ul style="list-style-type: none">• H(01 to 16) or• L(01 to 16)	0 to 19999	See Table 3-4

Table 3-4 shows the user default limit values for each set.

Table 3-4 Default user high/low limit values

Set	High limit (H)	Low limit (L)
U01	1000	900
U02	1200	1080
U03	1500	1350
U04	1800	1620
U05	2200	1980
U06	2700	2430
U07	3300	2970
U08	3900	3510
U09	4700	4230
U10	5600	5040

Table 3-4 Default user high/low limit values (continued)

Set	High limit (H)	Low limit (L)
U11	6800	6120
U12	8200	7380
U13	10000	9000
U14	12000	10800
U15	15000	13500
U16	18000	16200

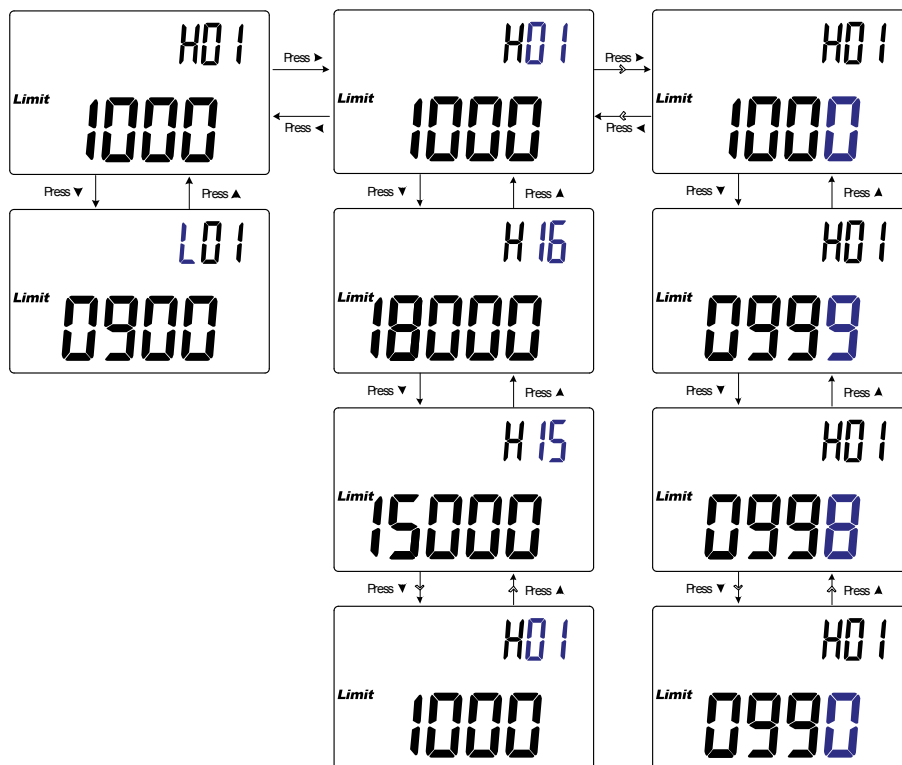

Figure 3-9 Changing the user high/low limit values

Changing the baud rate

This setting is used with the IR communication link and the Agilent GUI Data Logger software to control your LCR meter remotely (page 9).

Use this Setup item to change the baud rate for remote communications with a PC.

Parameter	Range	Default setting
bPS	(9600 or 19200) bits/second	9600 bits/second

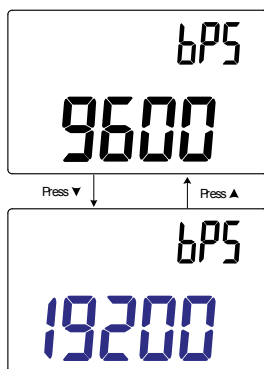

Figure 3-10 Changing the baud rate

Changing the parity check

This setting is used with the IR communication link and the Agilent GUI Data Logger software to control your LCR meter remotely (page 9).

Use this Setup item to change the parity check for remote communications with a PC.

Parameter	Range	Default setting
PA _r	nonE, En, or odd	nonE

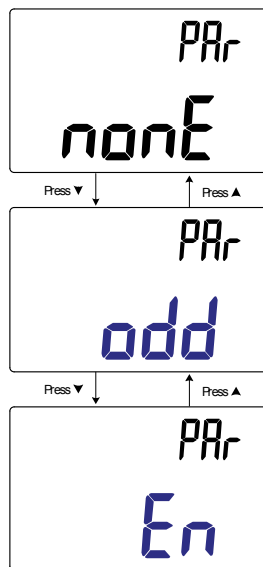

Figure 3-11 Changing the parity check

Changing the data bits

This setting is used with the IR communication link and the Agilent GUI Data Logger software to control your LCR meter remotely (page 9).

Use this Setup item to change the number of data bits (data width) for remote communications with a PC. The number of the stop bit is always 1, and this cannot be changed.

Parameter	Range	Default setting
dAt	7-bit or 8-bit	8-bit

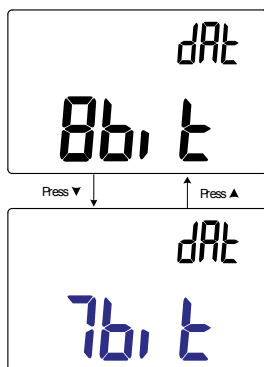

Figure 3-12 Changing the data bits

Changing the beep frequency

The LCR meter's beeper alerts users to the presence of newly sensed values for static recordings, sensed values that are out of tolerance or limits set, as well as invalid key operations.

Use this Setup item to change the driving frequency of the beeper.

Parameter	Range	Default setting
bEP	(2000, 3000, 4000) Hz or oFF	4000 Hz



Figure 3-13 Changing the beep frequency

Locking the push buttons

Use this Setup item to lock the push buttons (keys) of your LCR meter. If enabled, all keys will be locked (rendered unoperational) when you exit the Setup menu.

Unlock the push buttons again by entering the Setup menu through the power-on options ([page 10](#)).

Parameter	Range	Default setting
LPb	on or off	off

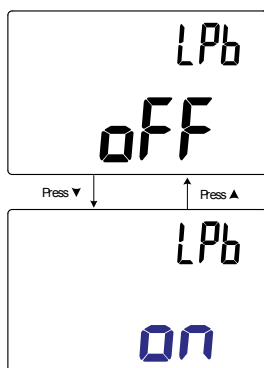

Figure 3-14 Locking the push buttons

Changing the auto power-off and backlight time-outs

The LCR meter's automatic power-off (see [page 6](#)) and backlight (see [page 6](#)) features use timers to determine when to turn off the backlight and when to automatically turn the LCR meter off.

Parameter	Range	Default setting
APo	(01 to 99) minutes or oFF	05 minutes
bLt	(01 to 99) seconds or oFF	30 seconds

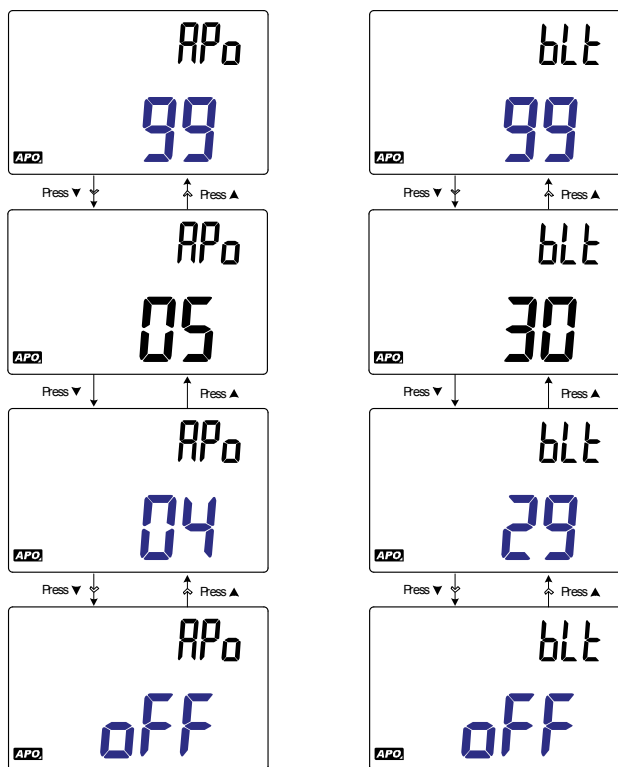



Figure 3-15 Changing the auto power-off and backlight time-outs

Resetting the Setup items

The Setup items can be reset to their default values through this Setup item.

Press  to perform the reset. The LCR meter will beep once, exit the Setup menu, and return to normal operation.

Parameter	Range	Default setting
rSt	dEFA	dEFA

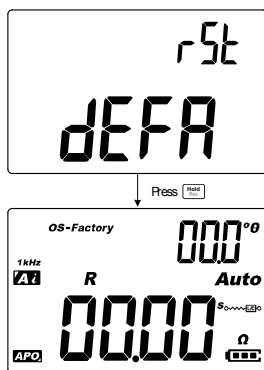
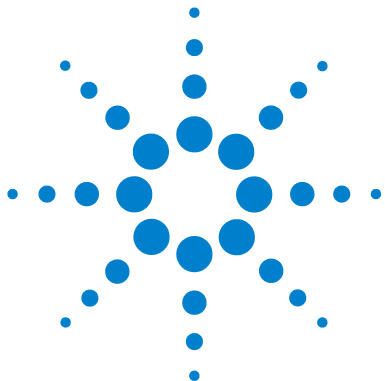

Figure 3-16 Resetting the Setup items



4 Characteristics and Specifications

Product Characteristics	76
Specification Assumptions	77
Electrical Specifications	78
Impedance/Resistance/DCR specifications	78
Capacitance specifications	79
Inductance specifications	80
Phase angle of impedance specifications	81
Dissipation/Quality factor specifications	82
Test signal specifications	83
Source impedance of impedance/resistance measurement	84
Source impedance of capacitance measurement	85
Source impedance of inductance measurement	86
SMD Tweezers Specifications	87
Electrical characteristics	88

This chapter lists the characteristics, assumptions, and specifications of the U1731C, U1732C, and U1733C handheld LCR meters.



Product Characteristics

NOTE

Product characteristics specified in the table below are applicable for all U1731C, U1732C, and U1733C models unless stated otherwise.

POWER SUPPLY

Battery type:

- 1 × 9 V Alkaline battery (ANSI/NEDA 1604A or IEC 6LR61), or
- 1 × 9 V Zinc Chloride battery (ANSI/NEDA 1604D or IEC 6F22)

Battery life:

- 16 hours typical (based on new Alkaline batteries without backlight enabled)
- Low battery indicator will flash when the battery voltage drops below 7.2 V (approximately)

External DC adapter

- DC 12 V ± 10% or 10.8 V_{MIN} to 13.2 V_{MAX}

POWER CONSUMPTION

225 mVA maximum (without backlight enabled)

DISPLAY

Dual display liquid crystal display (LCD)

- Primary display is 4 1/2 digits with maximum of 19999 counts
- Secondary display is 3 digits with maximum of 999 counts

MEASUREMENT RATE

- 1 time/second, nominal

OPERATING ENVIRONMENT

- Operating temperature from -10 °C to 55 °C, 0% to 80% RH
- Full accuracy up to 80% RH for temperatures up to 30 °C, decreasing linearly to 50% RH at 55 °C
- Altitude up to 2000 m
- Pollution degree II

STORAGE COMPLIANCE

-20 °C to 70 °C, 0% to 80% RH

SAFETY AND ELECTROMAGNETIC COMPATIBILITY (EMC) COMPLIANCE

- IEC61010-1:2001/EN61010-1:2001 (Second Edition)
- IEC 61326-1:2005/EN 61326-1:2006
- Canada: ICES/NMB-001:Issue 4, June 2006
- Australia/New Zealand: AS/NZS CISPR11:2004

TEMPERATURE COEFFICIENT

0.1 × (specified accuracy) / °C (from –10 °C to 18 °C, or 28 °C to 55 °C)

INPUT PROTECTION

Reset-able over-current protection.

DIMENSIONS (W × H × D)

87 × 184 × 41 mm

WEIGHT

337 grams (with battery)

WARRANTY

Please refer to http://www.agilent.com/go/warranty_terms

- Three years for product
- Three months for product's standard accessories, unless otherwise specified
- Please take note that for the product, the warranty does not cover:
 - Damage from contamination
 - Normal wear and tear of mechanical components
 - Manuals and standard disposable batteries

CALIBRATION CYCLE

One year

Specification Assumptions

- Accuracy is given as ±(% of reading + counts of least significant digit) at 23 °C ± 5 °C, with relative humidity less than 80% RH.
- The measurement performed at the component test socket and necessary open and short corrections must be done prior to verifying the instrument's accuracy.
- The accuracy is verified by design and specified type tests.

Electrical Specifications

NOTE

Specification assumptions are given on [page 77](#).

Impedance/Resistance/DCR specifications

Table 4-1 Impedance/Resistance/DCR specifications

Range	Resolution	Accuracy = $A_z + \text{Offset}$					
		DCR	100 Hz	120 Hz	1 kHz	10 kHz	100 kHz
		U1733C only	All models	All models	All models	U1733C and U1732C only	U1733C only
2 Ω ^[1]	0.0001 Ω	0.7% + 50	0.7% + 50	0.7% + 50	0.7% + 50	0.7% + 50	1.0% + 50
20 Ω ^[1]	0.001 Ω	0.7% + 8	0.7% + 8	0.7% + 8	0.7% + 8	0.7% + 8	0.7% + 8
200 Ω ^[1]	0.01 Ω	0.2% + 3	0.2% + 3	0.2% + 3	0.2% + 3	0.2% + 3	0.5% + 5
2000 Ω	0.1 Ω	0.2% + 3	0.2% + 3	0.2% + 3	0.2% + 3	0.2% + 3	0.5% + 5
20 k Ω	0.001 k Ω	0.2% + 3	0.2% + 3	0.2% + 3	0.2% + 3	0.2% + 3	0.5% + 5
200 k Ω	0.01 k Ω	0.5% + 5	0.5% + 5	0.5% + 5	0.5% + 5	0.5% + 5	0.7% + 8
2000 k Ω	0.1 k Ω	0.5% + 5	0.5% + 5	0.5% + 5	0.5% + 5	0.7% + 5	-
20 M Ω ^[2]	0.001 M Ω	2.0% + 8	2.0% + 8	2.0% + 8	2.0% + 8	5.0% + 8	-
200 M Ω ^[2]	0.01 M Ω	6.0% + 80	6.0% + 80	6.0% + 80	6.0% + 80	-	-

Notes:

- 1 The accuracy for the 2 Ω to 200 Ω range is specified after the Null function is used to subtract the resistance of test leads and the contact resistance.
- 2 For the 20 M Ω and 200 M Ω range, the RH is specified for <60%.
- 3 Resistance measurement is specified to $Q < 10$ and $D > 0.1$; otherwise accuracy is specified as $(A_z + \text{Offset}) \times \sqrt{1 + Q^2}$.
- 4 ESR (Equivalent Series Resistance) measurement is specified according to the impedance measurement and range. The maximum display is up to 199.99 k Ω and the accuracy is specified as $(A_z + \text{Offset}) \times \sqrt{1 + Q^2}$.

Capacitance specifications

Table 4-2 Capacitance specifications

Range	Resolution	Accuracy = A_C + Offset				
		100 Hz	120 Hz	1 kHz	10 kHz	100 kHz
		All models	All models	All models	U1733C and U1732C only	U1733C only
20 mF	0.001 mF	0.5% + 8	0.5% + 8	-	-	-
2000 μ F	0.1 μ F	0.5% + 5	0.5% + 5	0.5% + 8	-	-
200 μ F	0.01 μ F	0.3% + 3	0.3% + 3	0.5% + 5	0.5% + 8	-
20 μ F	0.001 μ F	0.2% + 3	0.2% + 3	0.2% + 3	0.5% + 5	5.0% + 10
2000 nF	0.1 nF	0.2% + 3	0.2% + 3	0.2% + 3	0.2% + 3	0.7% + 10
200 nF	0.01 nF	0.2% + 3	0.2% + 3	0.2% + 3	0.5% + 3	0.7% + 10
20 nF	0.001 nF	0.5% + 5	0.5% + 5	0.2% + 3	0.5% + 3	0.7% + 10
2000 pF ^[1]	0.1 pF	0.5% + 10	0.5% + 10	0.5% + 5	0.5% + 3	2.0% + 10
200 pF ^[1]	0.01 pF	-	-	0.5% + 10	0.8% + 10	2.0% + 10
20 pF ^[1]	0.001 pF	-	-	-	1.0% + 20	2.5% + 10

Notes:

- 1 The accuracy for the 20 pF to 2000 pF range is specified after the Null function is used to subtract the stray capacitance of the test leads.
- 2 The accuracy for the ceramic capacitor will be influenced depending on the dielectric constant (K) of the material used to make the ceramic capacitor. For related influence factors, please refer to the *Component dependency factors* section in the *Impedance Measurement Handbook*, downloadable for free at <http://www.agilent.com/find/lcmmeters>.

Inductance specifications

Table 4-3 Inductance specifications

Range	Resolution	Accuracy = A_L + Offset				
		100 Hz	120 Hz	1 kHz	10 kHz	100 kHz
		All models	All models	All models	U1733C and U1732C only	U1733C only
20 μ H	0.001 μ H	-	-	-	1.0% + 5	2.5% + 20
200 μ H	0.01 μ H	-	-	1.0% + 5	0.7% + 3	2.5% + 20
2000 μ H	0.1 μ H	0.7% + 10	0.7% + 10	0.5% + 3	0.5% + 3	0.8% + 20
20 mH	0.001 mH	0.5% + 3	0.5% + 3	0.2% + 3	0.3% + 3	0.8% + 10
200 mH	0.01 mH	0.5% + 3	0.5% + 3	0.2% + 3	0.2% + 3	1.0% + 10
2000 mH	0.1 mH	0.2% + 3	0.2% + 3	0.2% + 3	0.5% + 5	1.0% + 10
20 H	0.001 H	0.2% + 3	0.2% + 3	0.5% + 5	1.0% + 5	2.0% + 10
200 H	0.01 H	0.7% + 5	0.7% + 5	1.0% + 5	2.0% + 8	-
2000 H	0.1 H	1.0% + 5	1.0% + 5	2.0% + 8	-	-

Phase angle of impedance specifications

Table 4-4 Phase angle of impedance specifications

Range	Resolution	Accuracy = θ_e	Condition
-180° to 180°	0.1°/1°	$\left(A_Z + \frac{Offset}{Z_x}\right) \times \frac{180}{\pi}$	D < 1 or Q > 1

Notes:

- 1 The A_Z and *Offset* variables are the accuracy specified at [Table 4-1](#), “Impedance/Resistance/DCR specifications,” on page 78.
- 2 The π variable is rounded up to 3.14159.
- 3 The table below shows an example of the calculations for the phase angle of impedance:

Impedance	Z_x	A_Z	Offset	θ_e
1999.9 Ω	19999	0.2%	3	$\pm 0.12^\circ$
199.9 Ω	1999	0.2%	3	$\pm 0.20^\circ$
19.9 Ω	199	0.2%	3	$\pm 0.98^\circ$
1.9 Ω	19	0.2%	3	$\pm 9.16^\circ$

4 Characteristics and Specifications

Electrical Specifications

Dissipation/Quality factor specifications

Table 4-5 Dissipation/Quality factor specifications

Range	Resolution	Accuracy = D_e	Condition
Z	0.001 to 999	$A_Z + \frac{Offset}{Z_x} \times 100\% + 3$	$D < 1$ or $Q > 1$
L	0.001 to 999	$A_L + \frac{Offset}{L_x} \times 100\% + 3$	$D < 1$ or $Q > 1$
C	0.001 to 999	$A_C + \frac{Offset}{C_x} \times 100\% + 3$	$D < 1$ or $Q > 1$

Notes:

- 1 The A_Z , A_L , A_C , and *Offset* variables are the accuracy specified at [Table 4-1](#), [Table 4-2](#), and [Table 4-3](#) respectively.
- 2 The Z_x , L_x , and C_x variables are the display count of the reading. For example, the C_x value is 8888 if the capacitance is 88.88 μF for the range of 200 μF .
- 3 The quality factor is the reciprocal of the dissipation factor.
- 4 The calculation example below is for the 120 Hz frequency:

Capacitance	C_x	A_C	Offset	D_e
88.88 μF	8888	0.3%	3	0.334% + 3

Test signal specifications

Table 4-6 Test signal specifications

Selection		Test signal level		Test frequency	
		Level	Accuracy	Frequency	Accuracy
100 Hz	All models	0.74 Vrms	0.05 Vrms	100 Hz	0.01%
120 Hz	All models	0.74 Vrms	0.05 Vrms	120.481 Hz	0.01%
1 kHz	All models	0.74 Vrms	0.05 Vrms	1 kHz	0.01%
10 kHz	U1733C and U1732C only	0.70 Vrms	0.05 Vrms	10 kHz	0.01%
100 kHz	U1733C only	0.70 Vrms	0.05 Vrms	100 kHz	0.01%
DCR	U1733C only	1.235 V	0.05 V	-	-

4 Characteristics and Specifications

Electrical Specifications

Source impedance of impedance/resistance measurement

Table 4-7 Source impedance of impedance/resistance measurement

Range	Typical source impedance					
	DCR	100 Hz	120 Hz	1 kHz	10 kHz	100 kHz
	U1733C only	All models	All models	All models	U1733C and U1732C only	U1733C only
2 Ω	100 Ω	100 Ω	100 Ω	100 Ω	100 Ω	100 Ω
20 Ω	100 Ω	100 Ω	100 Ω	100 Ω	100 Ω	100 Ω
200 Ω	100 Ω	100 Ω	100 Ω	100 Ω	100 Ω	100 Ω
2000 Ω	1 k Ω	1 k Ω	1 k Ω	1 k Ω	1 k Ω	1 k Ω
20 k Ω	10 k Ω	10 k Ω	10 k Ω	10 k Ω	10 k Ω	1 k Ω
200 k Ω	100 k Ω	100 k Ω	100 k Ω	100 k Ω	10 k Ω	1 k Ω
2000 k Ω	100 k Ω	100 k Ω	100 k Ω	100 k Ω	10 k Ω	-
20 M Ω	100 k Ω	100 k Ω	100 k Ω	100 k Ω	100 k Ω	-
200 M Ω	100 k Ω	100 k Ω	100 k Ω	100 k Ω	-	-

Source impedance of capacitance measurement

Table 4-8 Source impedance of capacitance measurement

Range	Typical source impedance				
	100 Hz	120 Hz	1 kHz	10 kHz	100 kHz
	All models	All models	All models	U1733C and U1732C only	U1733C only
20 mF	100 Ω	100 Ω	-	-	-
2000 μF	100 Ω	100 Ω	100 Ω	-	-
200 μF	100 Ω	100 Ω	100 Ω	100 Ω	-
20 μF	100 Ω	100 Ω	100 Ω	100 Ω	100 Ω
2000 nF	1 kΩ	1 kΩ	100 Ω	100 Ω	100 Ω
200 nF	10 kΩ	10 kΩ	1 kΩ	100 Ω	100 Ω
20 nF	100 kΩ	100 kΩ	10 kΩ	1 kΩ	100 Ω
2000 pF	100 kΩ	100 kΩ	100 kΩ	10 kΩ	1 kΩ
200 pF	-	-	100 kΩ	10 kΩ	1 kΩ
20 pF	-	-	-	10 kΩ ^[1]	1 kΩ

[1] This specification value is applicable for firmware versions 00.21 and above only. For firmware versions below 00.21, the impedance value is set at 100 kΩ.

4 Characteristics and Specifications

Electrical Specifications

Source impedance of inductance measurement

Table 4-9 Source impedance of inductance measurement

Range	Typical source impedance				
	100 Hz	120 Hz	1 kHz	10 kHz	100 kHz
	All models	All models	All models	U1733C and U1732C only	U1733C only
20 μ H	-	-	-	100 Ω	100 Ω
200 μ H	-	-	100 Ω	100 Ω	100 Ω
2000 μ H	100 Ω	100 Ω	100 Ω	100 Ω	100 Ω
20 mH	100 Ω	100 Ω	100 Ω	100 Ω	100 Ω
200 mH	100 Ω	100 Ω	100 Ω	1 k Ω	1 k Ω
2000 mH	100 Ω	100 Ω	1 k Ω	10 k Ω	1 k Ω
20 H	1 k Ω	1 k Ω	10 k Ω	10 k Ω	1 k Ω
200 H	10 k Ω	10 k Ω	100 k Ω	10 k Ω ^[1]	-
2000 H	100 k Ω	100 k Ω	100 k Ω	-	-

[1] This specification value is applicable for firmware versions 00.21 and above only. For firmware versions below 00.21, the impedance value is set at 100 k Ω .

SMD Tweezers Specifications

The Agilent U1782B is a tweezers to be used with the U1700 Series Handheld LCR Meters. This tweezers is useful when measuring SMD-type components. Plug in the base of the tweezers to the LCR meter's + (HI-SENSE), - (LO-SENSE) and GUARD ends. Ensure that the orientation of the base matches the polarity of the LCR meter.

It is recommended to measure the SMD components length as well as the maximum opening of the tweezers. The length of the tweezers is approximately 815 mm (32.08 inches) (see Figure 4-1).

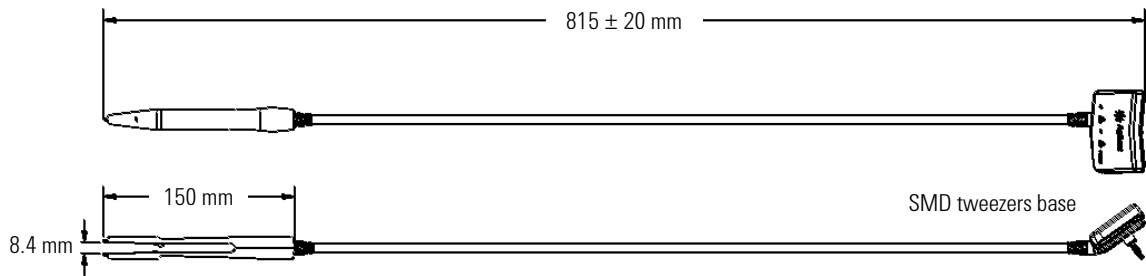

Figure 4-1 U1782B SMD tweezers

4 Characteristics and Specifications

SMD Tweezers Specifications

Electrical characteristics

Table 5 U1782B SMD tweezers electrical characteristics

Parameters	Test condition	100 Hz	120 Hz	1 kHz	10 kHz	100 kHz
Cp Parallel capacitance	Tweezers open	<0.7 pF	<0.7 pF	<0.7 pF	<0.7 pF	<0.7 pF
Rs Series resistance	Tweezers short	<0.5 Ω	<0.5 Ω	<0.5 Ω	<0.5 Ω	<0.5 Ω
Ls Series inductance	Tweezers short	<1.2 μ H	<1.2 μ H	<1.2 μ H	<1.2 μ H	<1.2 μ H

Notes:

- 1 The accuracy is specified at 23 °C \pm 5 °C and <75% R.H.
- 2 You are recommended to perform an open/short calibration on the LCR meter before using the tweezers.

www.agilent.com

Contact us

To obtain service, warranty, or technical assistance, contact us at the following phone or fax numbers:

United States:

(tel) 800 829 4444 (fax) 800 829 4433

Canada:

(tel) 877 894 4414 (fax) 800 746 4866

China:

(tel) 800 810 0189 (fax) 800 820 2816

Europe:

(tel) 31 20 547 2111

Japan:

(tel) (81) 426 56 7832 (fax) (81) 426 56 7840

Korea:

(tel) (080) 769 0800 (fax) (080) 769 0900

Latin America:

(tel) (305) 269 7500

Taiwan:

(tel) 0800 047 866 (fax) 0800 286 331

Other Asia Pacific Countries:

(tel) (65) 6375 8100 (fax) (65) 6755 0042

Or visit Agilent World Wide Web at:

www.agilent.com/find/assist

Product specifications and descriptions in this document are subject to change without notice. Always refer to the Agilent website for the latest revision.

© Agilent Technologies, Inc., 2011–2012

Seventh Edition, November 28, 2012
U1731-90077



Agilent Technologies